



## RT50-R Retro SCOOTER

Read this manual carefully. It contains important safety information.  
No one under the age of 16 should operate this scooter.

# OWNER'S MANUAL

**Minimum Recommended Age  
Requirement 16**



Rev. G  
030509

**Always wear a helmet; It could save your Life!**

Do not remove this operator's manual from this vehicle.  
Please obtain, review, and follow provincial / municipal government acts and regulations  
pertaining to owning and operating this scooter.



**Congratulations on your purchase of the BAJA INC. RT50-R Retro Scooter.**

**Your Scooter is warranted to be free of manufacturing defects in material and workmanship for a period of 90 days from the date of purchase. During the warranty period BAJA INC. will at its option, repair, provide replacement parts or replace your BAJA INC. 50cc Scooter at no charge. This warranty does not cover normal wear items or damage caused by neglect or misuse of the product.**

**Engine Warranty – 90 days**

**Frame Warranty – 90 days**

**Warranty is void if:**

**Frame is bent or broken due to abuse**

**Wheels are bent or broken**

**Fender bent or broken due to abuse**

**Any sign of impact, accident, jumping, spin-outs or roll over.**

**BAJA INC. is not liable for any damage claim or liability claim person or otherwise resulting from the operation of this product in any way.**

**Should you experience a problem with your vehicle, please call the Baja INC. customer service line toll free at 1-888-863-2252 between the hours of 7am and 5pm Monday through Friday MST (Mountain Standard Time). MDT (Mountain Daylight Time) during daylight saving time. You will be instructed how to proceed.**

**A COPY OF THE SALES RECEIPT IS REQUIRED.**

 **WARNING**

This manual should be considered as a permanent part of the vehicle and should remain with the vehicle when resold or otherwise transferred to a new user or operator. The manual contains important safety information and instructions which should be read carefully before operating the vehicle. All operators should obtain, review, and follow provincial and municipal government acts and regulations pertaining to owning and operating an on-road vehicle. Children under the age of 16 should never operate this vehicle.

 **WARNING**

It is the operators responsibility to know and obey all applicable local, state and federal laws at all times while operating this vehicle including but not limited to traffic safety, vehicle registration, emissions, and noise.

 **WARNING**

The exhaust from this product contains chemicals known to the State of California to cause cancer, birth defects or other reproductive harm. CALIFORNIA PROPOSITION 65

# Table of Contents

IMPORTANT .....	2
GENERAL PRECAUTIONS/WARNINGS .....	3
NHTSA SAFETY NOTICE.....	8
PRE RIDE CHECK LIST .....	9
LOCATION OF WARNING LABEL.....	10
FUEL AND OIL.....	13
OPERATION .....	14
STARTING THE ENGINE.....	14
DRIVING SAFELY .....	15
SHUTTING OFF THE ENGINE .....	16
STOPPING THE VEHICLE .....	16
PARKING .....	16
BREAKING IN.....	16
IGNITION SWITCH .....	17
BRAKE LEVERS AND THROTTLE.....	17
RIGHT BRAKE/SWITCH ASSEMBLY .....	18
KICK STARTER .....	19
LEFT BRAKE/SWITCH ASSEMBLY .....	19
INSTRUMENT PANEL .....	20
SEAT LOCK.....	20
FUEL TANK.....	21
MAINTENANCE.....	22
CHECKING AND CHANGING ENGINE OIL.....	22
CLEANING OIL FILTER.....	22
CHANGING TRANSMISSION OIL.....	23
SPARK PLUG.....	23
AIR FILTER .....	24
BRAKES .....	25
IDLE SPEED ADJUSTMENT/FUEL HOSE INSP. ....	26
TIRES .....	27
BATTERY.....	28
TRANSPORTING.....	32
STORAGE PROCEDURE.....	33
MAINTENANCE CHART .....	34
TROUBLESHOOTING .....	35
SPECIFICATIONS.....	37
ELECTRICAL DIAGRAM.....	38
SERIAL NUMBER LOCATION .....	39
EMISSION CONTROL SYSTEM WARRANTY.....	40

# Important

Please read this manual and follow all instructions carefully. To emphasize the special information, the symbol **▲** and the words **WARNING** or **CAUTION** have some special meanings. Pay attention to the messages.

<b>▲ WARNING</b>
Indicates a potential hazard that could result in death or injury.

<b>CAUTION</b>
Indicates a potential hazard that could result in vehicle damage.

**NOTE:** Indicating special information which is to make maintenance easier or instructions clearer.

**WARNING** and **CAUTION** are arranged like this:

<b>▲ WARNING-or-CAUTION</b>
The first part will identify a <b>POTENTIAL HAZARD</b> .
The second part will describe <b>WHAT COULD HAPPEN</b> if you ignore the <b>WARNING</b> or <b>CAUTION</b> .
The third part will describe <b>HOW TO AVOID THE HAZARD</b> .

This user's manual contains important safety and maintenance information. Read it carefully before riding. Failing to follow the warnings contained in this manual could result in **INJURY** or **DEATH**.

It is important that this manual remain with the vehicle when you transfer it to another user or owner.

All information, illustrations, photographs and specifications contained in this manual are based on the latest product information available at the time of publication. Due to improvements or other changes, there will be some discrepancies in this manual. We reserve the right to make product changes at any time, without notice and without incurring any obligation to make the same or similar changes to the vehicle previously built or sold.

# General Precautions



**WARNING! FAILURE TO FOLLOW THESE INSTRUCTIONS CAN RESULT IN SEVERE INJURY OR DEATH.**

**CAUTION: FAILURE TO FOLLOW THESE INSTRUCTIONS CAN ALSO RESULT IN DAMAGE TO THE VEHICLE AND/OR OTHER PROPERTY.**

- Read and follow all instructions in this Owner's/Operator's Manual, any accompanying supplements, Do not discard this owner's manual, safety video, or any other material or documentation included with this vehicle.
- Exhaust fumes are toxic. California Proposition 65 warning: Gasoline engine exhaust from this vehicle contains chemicals known to the State of California to cause cancer, birth defects, or other reproductive harm. The engine exhaust contains carbon monoxide, which is tasteless, odorless, poisonous gas. Never operate this vehicle indoors or in an enclosed area with poor ventilation.
- This vehicle may have been supplied to you completely assembled. To prevent possible injury or death, read and follow the assembly instructions to make sure the vehicle was assembled properly.
- Always perform the daily pre-ride inspection specified in this manual before operating this vehicle.
- Modifying the vehicle and/or removing original equipment and/or safety decals could make this vehicle unsafe for operation.
- Replace any safety decals that become unreadable or detached from the vehicle. Decals provide critical warnings about potential hazards or safety requirements.
- Never use this vehicle for stunt riding, spin outs, donuts, racing , or any form of competition.

## **Additional Warnings**

### **Protective Clothing/Equipment**

- **Most accident fatalities are due to preventable head injuries. Always wear a properly fitting motorcycle type helmet approved by agencies such as the Department of Transportation (DOT), Safety Helmet Council of America (SHCA), or Snell Memorial Foundation (SNELL).**
- **Always wear face shields or goggles, boots, gloves and other appropriate protective clothing.**
- **Long hair, loose clothes, or jewelry can get caught in moving parts below and behind the seat or your surrounding environment. Remove or tie back anything loose that can reach below and behind the seat before riding.**

### **Moving Parts**

- **Never place hands, feet, any body parts or clothing near the engine, wheels, chain and other rotating parts of the vehicle while riding or running the engine.**
- **Use extreme caution when performing required maintenance while the engine is running.**
- **Keep guards and pads in place at all times. Prevent accidental contact by any person whenever the vehicle is running.**
- **The guards over the brake, clutch, torque-converter, axle and drive sprockets also help prevent mud and debris from contacting those components.**

### **Traffic Safety**

- **ALWAYS FOLLOW THE ENTIRE PRE-RIDE CHECKLIST PRIOR TO STARTING OR RIDING THE SCOOTER.**
- **Your safety while riding this vehicle depends entirely on your ability to exercise proper judgement. You must be of sufficient age, understanding, mental capacity, and physical capability to safely operate this vehicle.**

## **Additional Warnings (continued)**

### **Traffic Safety (continued)**

- Always obtain mature, supervised instruction and sufficient practice in an uncongested area before operating this vehicle on any public thoroughfare.
- Excessive vehicle speed is a leading cause of accidents, which can cause death or serious harm to you, other people, and/or property. Always obey all applicable traffic safety laws while operating this vehicle, being sure to account for current weather and traffic conditions and slow down if necessary. **DRIVE TO ARRIVE!**
- Use extreme caution when riding on wet, slippery, rough or sloped terrain. There is an increased risk of loss of control, which can result in injury, death, and/or property damage.
- Always slow down when turning. High-speed turning can cause loss of control and/or possible death, injury, and/or property damage. Practice turning in a safe area away from traffic until you are confident in your ability to control the vehicle at all times.
- Operating this vehicle at an unsafe speed, especially while turning, can cause death, injury, and/or property damage.
- Never use this vehicle to perform any type of racing, stunt riding, jumps, spin-outs, donuts, or other maneuvers, You could kill or injure yourself or others and/or cause property damage.
- Never operate vehicle while under the influence of alcohol, drugs or medication of any kind. Such operation is dangerous to yourself and/or others.
- Check the tire pressure before operating the vehicle using a properly calibrated tire air pressure gauge.
- Stop the vehicle and shut off the engine immediately if the vehicle makes unusual noises or vibrations. Check the vehicle for damage. Excessive noise or vibration is a sign of loose or worn parts.



## **Additional Warnings (continued)**

### **Engine/Motor Safety**

- **Keep the engine/motor free of dirt and debris, especially in the throttle linkage area.**
- **Never start the engine/motor without checking to see that the throttle control is in the idle position.**
- **Never start the engine/motor unless you are properly seated with your hands firmly on the controls.**
- **Never tamper with, alter, or change the vehicle's engine/motor settings. The engine/motor governor is factory set and protects the engine/motor from damage. Excessive engine/motor speed is potentially dangerous to the operator, bystanders, and the engine/motor itself.**
- **All guards must be in place prior to starting the engine.**
- **Operating the vehicle in conditions where water, mud, snow, dirt, sand or other debris can get into the throttle cable conduit and/or the throttle mechanism can cause the cable or throttle mechanism to bind, which may lead to throttle sticking, loss of control, and possible death, injury, and/or property damage.**

### **Fasteners**

- **Make sure that all screws, nuts, and bolts are properly tightened. Never over-tighten hardware that is designed to move, such as front and rear wheels. Restricting moving parts can cause a loss of control and possible injury or death.**
- **Always replace torque-type locknuts with new locknuts of the same type after removing the old locknuts.**

## **Additional Warnings (continued)**

### **Fueling**

- **Check the fuel supply before each use. Never fill the fuel tank while the engine is running or hot. Always allow at least 1in. of expansion space at the top of the fuel tank. There should not be any fuel in the filler neck. Replace the fuel cap tightly after refueling to prevent a fuel spillage, fire, or explosion hazard.**
- **Always use an original gas cap or an approved OEM replacement. Never fill fuel tank while the vehicle is inside a building. Gasoline vapors can cause injury or death and can pose a fire or explosion risk.**
- **Move the vehicle at least 10 ft. before starting the engine.**
- **Use extreme caution when starting the engine. Hot engine, muffler, or drive components can cause serious burns on contact.**

### **Maintenance**

- **Do not modify the vehicle from the manufacturer's original design and configuration.**
- **Never wash or operate the vehicle in freezing temperatures. Water can freeze in the throttle cable conduit and/or on the throttle mechanism, possibly resulting in throttle sticking, which can cause the engine to continue to run and result in loss of control.**
- **Assembly, maintenance, and/or repair of this vehicle should only be performed by designated dealers or authorized repair centers to ensure quality work and safe vehicle condition.**
- **Always disconnect the spark plug wire (gasoline vehicles) or disconnect the battery before commencing any work in the engine vicinity or where there is a possibility that the vehicle could move unexpectedly. Keep the spark plug cable away from the spark plug to avoid accidental starting.**
- **Avoid contacting the muffler, cylinder head, or any potentially hot area on or around the engine when working on, around, or restarting the engine.**

## **Additional Warnings (continued)**

### **Maintenance (continued)**

- Store this vehicle in a place where gasoline fumes cannot reach an open flame, spark, or other source of ignition. Drain the fuel tank in a cool well-ventilated area prior to any long-term storage. Never store this vehicle in a close proximity to appliances such as water heaters or furnaces.
- Engine, exhausts, and other components can become extremely hot during operation. Use caution when near hot components.
- Never adjust, repair, or clean the vehicle while it is in motion.

### **NHTSA Safety Notice**

If you believe that your vehicle has a defect which could cause serious injury or death, you should immediately contact the National Highway Traffic Safety Administration (NHTSA) in addition to notifying BAJA INC.

If NHTSA receives similar complaints, it may open an investigation and if it finds that a safety defect exists in a group of vehicles, it may order a recall and remedy campaign.

However, NHTSA cannot become involved in any individual problems between you, your dealer or BAJA INC.

To contact NHTSA you may call the Auto Safety Hotline toll-free within the United States on 1-800-424-9393 or write to: NHTSA, 400 Seventh Street SW, Washington, DC 20590.

# Pre-Ride Checklist



**WARNING! ALWAYS PERFORM THE ENTIRE PRE-RIDE CHECKLIST BEFORE USING THE VEHICLE AS THIS CAN HELP YOU SPOT PROBLEMS THAT COULD INTERFERE WITH SAFE VEHICLE OPERATION. FAILURE TO FOLLOW THIS ENTIRE CHECKLIST BEFORE EVERY RIDE CAN CAUSE DEATH, SERIOUS INJURY, AND/OR PROPERTY DAMAGE TO YOURSELF AND/OR OTHERS**

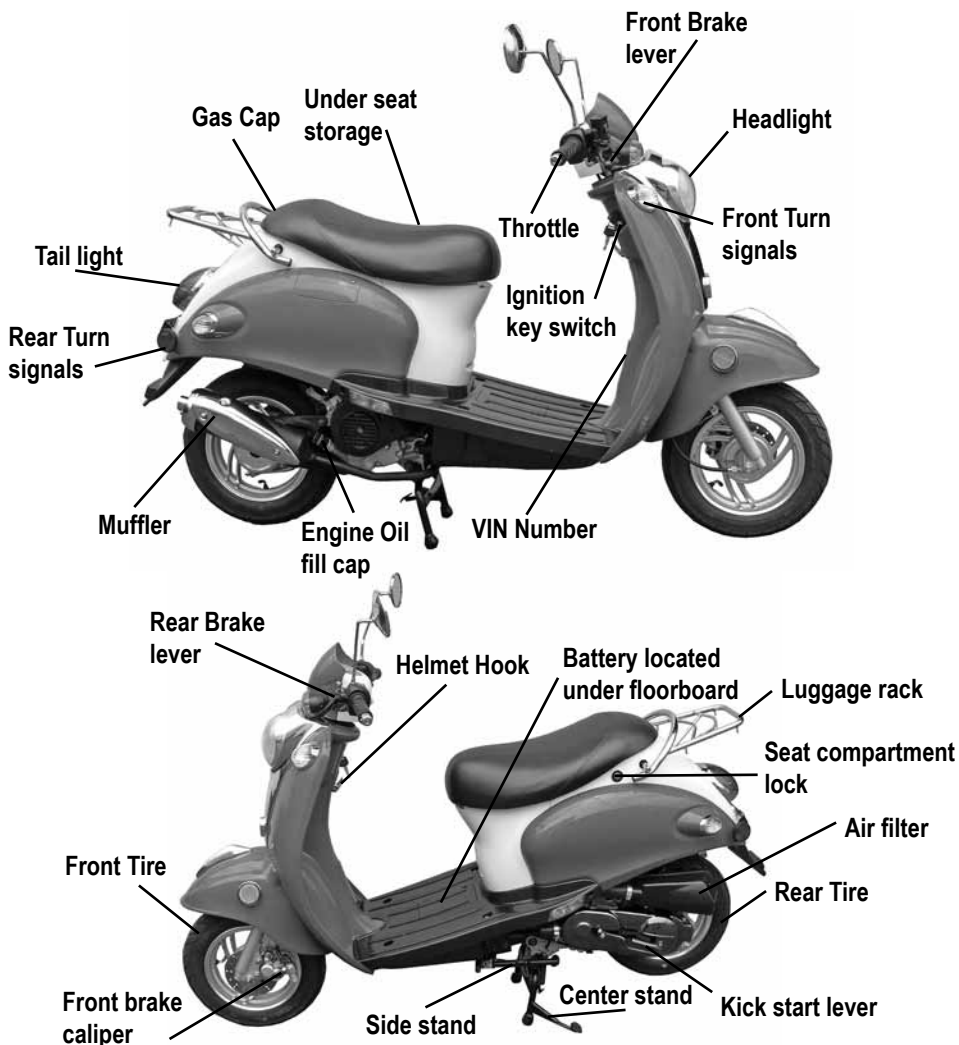

## Location of Warning Label

Read and follow the warning label on your Scooter. Make sure you understand the label. Keep the label on the Scooter. Do not remove it for any reason. If the label comes off or becomes difficult to read, you should get a replacement by contacting BAJA INC.

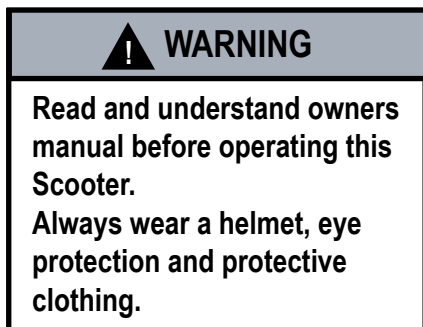

# **Pre-Ride Checklist (continued)**

## **Before Starting the Engine/Motor**

1. Engine oil level
  - a) Check for leaks
  - b) Tighten filler cap securely.
  - c) Add oil if required.
  
2. Fuel level
  - a) Add fuel as necessary.
  - b) Do not overfill (no fuel in the filler neck).
  - c) Do not mix oil with gas.
  - d) Replace cap tightly.
  - e) Do not refuel a hot engine. Allow engine to cool before adding fuel.
  
3. Warning decals
  - a) Make sure all warning decals are legible and securely attached.
  - b) Replace as necessary.
  
4. Tires
  - a) Ensure that both tires have at least 1/8 in. tread depth at center.
  - b) Both tires must be inflated to the pressure indicated on the tire sidewalls.
  - c) Replace the tires if tread height is less than 1/8 in. at the center of tires.
  
5. Throttle
  - a) Check for smooth operation. Make sure the throttle “snaps” back to idle position when released.
  - b) Check for frayed cable or damaged cable housing. Replace damaged cable.
  - c) Check for mud, debris and ice in the throttle cable/mechanism. Clean out any contamination.

## **Pre-Ride Checklist (continued)**

### **Before Starting the Engine/Motor**

#### **6. Fasteners**

- a) Check that axle nuts are secure.
- b) Check for missing fasteners. Replace as necessary.
- c) Check that all other fasteners are secure. Tighten as necessary.

#### **7. Steering**

Make sure steering turns freely.

#### **8. Frame/chassis**

Check for bent/damaged frame/chassis components. Replace as necessary.

#### **9. Battery (if equipped)**

Check to make sure connections are tight and corrosion-free.  
Clean/tighten as necessary.

#### **10. Lights (if equipped)**

Check for proper operation. Replace bulbs as necessary.

# FUEL AND OIL

## FUEL

The proper fuel is very important for the engine. Ensure that there is no dust, dirt, or water which has mixed in the fuel. Please use regular unleaded 89 octane or higher gasoline.

## ENGINE OIL

Your scooter has a four-stroke engine. Please use oil as described in the chart below. By using the prescribe oil, you will realize the best lubrication for the engine. Oil Capacity: 0.5 qt. (0.47 L)

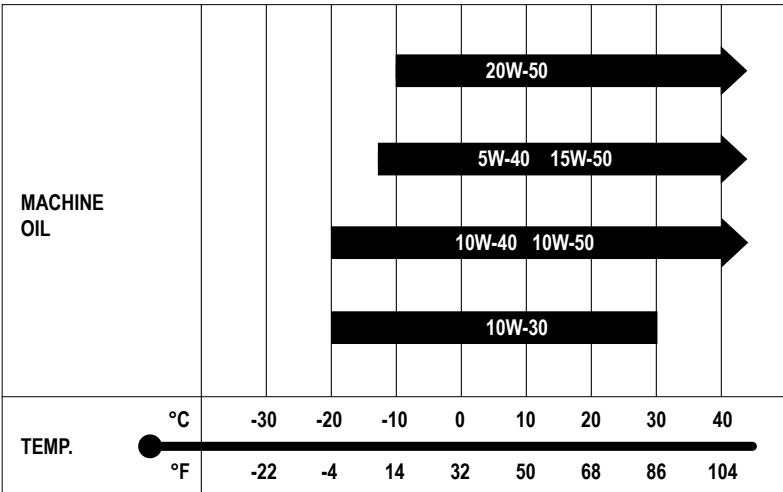

Use the chart to select a viscosity rating based on the temperature range in your area.



## Operation

### Starting the Engine



**WARNING! ALWAYS RETRACT THE SIDE STAND (2) PRIOR TO STARTING THE VEHICLE.**

**If the engine is cold:**

**Balance the scooter on its center stand (1) with the side kick stand (2) fully retracted. Make sure the ignition key is OFF, then rotate the throttle 5-8 times to prime the engine. Squeeze the rear brake lever, turn the key to RUN, and push the START button. Your scooter includes an automatic choke.**

**CAUTION: DO NOT RUN THE STARTER FOR MORE THAN 5 SECONDS AT A TIME. ALWAYS ALLOW AT LEAST 10 SECONDS BETWEEN STARTING ATTEMPTS.**

**If the engine is warm:**

**Balance the scooter on its center stand (1) with the side stand (2) fully retracted. Squeeze the rear brake lever, turn the key to RUN, and push the START button. If the engine does not start after 5 seconds wait 10 seconds, then turn the throttle 1/3 turn while pressing the START button. This will override the automatic choke and help start the engine.**

**CAUTION: DO NOT RUN THE STARTER FOR MORE THAN 5 SECONDS AT A TIME. ALWAYS ALLOW AT LEAST 10 SECONDS BETWEEN STARTING ATTEMPTS.**

## Operation (continued)

### Driving Safely



**WARNING! FOLLOW ALL OF THE WARNINGS IN THIS OPERATOR'S MANUAL AT ALL TIMES WHILE OPERATING THE SCOOTER. IT IS YOUR RESPONSIBILITY TO KNOW AND OBEY ALL APPLICABLE LOCAL, STATE, AND FEDERAL LAWS.**



**WARNING! NEVER OVERLOAD THE VEHICLE. THE CARRYING CAPACITY IS 251 lbs. (114kg).**

After starting the engine, hold rear (left) brake lever and gently push the scooter forward off the center stand.

Straddle the seat while keeping one foot on the ground for stability. Slowly turn the throttle to begin driving. Place your foot on the floorboard as the scooter begins moving.

Never attach any articles to the handlebar. Stow any cargo on the luggage rack or in the under-seat storage box. Do not carry cargo weighing more than 10 pounds on the luggage rack. Always hold the rear hand hold when lifting the scooter.



**WARNING! ALWAYS WEAR A DOT-APPROVED HELMET, EYE PROTECTION, AND SHOES WHEN RIDING YOUR VEHICLE.**



**WARNING! NEVER DRIVE THE SCOOTER WITH THE SIDE STAND EXTENDED.**

## Operation (continued)

### Shutting off the engine

Always shut off the engine by turning the ignition switch to OFF.

### Stopping the vehicle



**WARNING! WET, OIL, OR SANDY ROADS REDUCE BRAKING EFFECTIVENESS. HARD BRAKING ON THESE SURFACES COULD LEAD TO LOSS OF CONTROL AND A SERIOUS ACCIDENT. ALWAYS REDUCE SPEED AS GRADUALLY AS POSSIBLE.**

When braking, always engage the rear brake first to retain maximum control of the scooter. Most of your stopping power comes from the front wheel.

### Parking

Always leave the ignition key assembly in the lock position when parking the vehicle to help prevent theft. Park on smooth hard surfaces, use the center stand whenever possible.

### Breaking in

- Following this break-in procedure ensures that your scooter is functioning properly and maximizes engine life.
- Never drive this vehicle over 25mph during the first 250 miles of operation. Excessive speed could result in engine failure.
- Always use fresh 89 octane gasoline. Avoid gasoline that contains alcohol, which can damage rubber gaskets and engine seals.
- Check and adjust the brakes, throttle cable, tire pressure, and fasteners weekly before riding. This is in addition to the pre-ride inspection.
- Schedule regular maintenance with your authorized Baja Inc. service center.
- Never add oil to the gasoline; your scooter has a 4-stroke engine with an internal lubricating system.

## Operation (continued)

### Ignition switch

The main ignition switch contains three positions:

- **ON (2):** The engine can start, the key (1) cannot be removed.
- **OFF (3):** This position shuts off the engine and allows the key to be removed.
- **LOCK (4):** From the OFF position, push inward and turn the key counterclockwise to the LOCK position while turning the steering column to the left and shaking it lightly to engage the steering lock. Remove key.

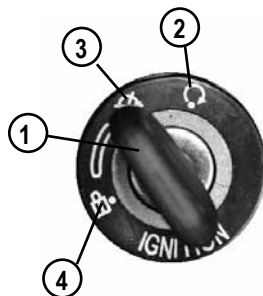

### Brake Levers and Throttle

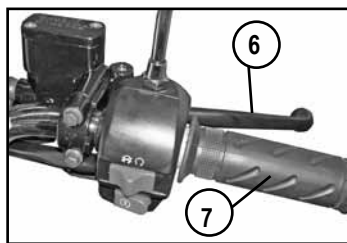
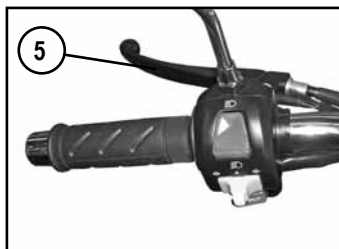

- **Rear brake (5):** When stopping the scooter, squeeze the rear brake smoothly and firmly. Always engage the rear brake first.
- **Front brake (6):** Squeeze the lever gently at first to avoid locking the front wheel. Most of your stopping power comes from the front wheel, which should always be used to supplement the rear wheel.



**WARNING! USE EXTREME CAUTION WHEN ENGAGING THE FRONT BRAKE TO AVOID LOCKING THE FRONT WHEEL. LOCKING THE FRONT WHEEL CAN CAUSE A SERIOUS ACCIDENT.**

- **Throttle grip (7):** The rotary throttle grip is on the right handlebar. Accelerate by rotating the throttle towards you. Gently apply the throttle to avoid engine from stalling. Decelerate by rotating the throttle away from you. The throttle includes a safety spring that snaps the throttle back to idle when released.

## Operation (continued)

### Right switch assembly

- **On/Off Safety stop Switch (1)**

The On/Off safety stop switch needs to be at “on” position before scooter will start. The safety stop switch is available in case of an emergency.

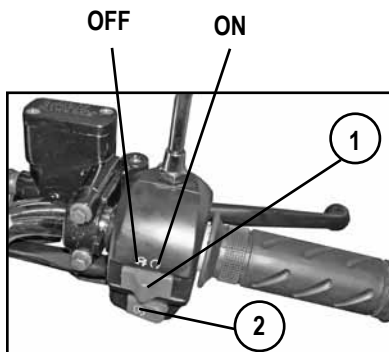

- **Electric starter switch (2)**

The electric starter switch is located directly under On/Off safety stop switch. In order for scooter to start, the key will need to be turned to “on” position as well as the safety stop switch. Depress the electric starter switch to start the engine. Never run the starter for more than 5 seconds at a time. Allow at least 10 seconds between each starting attempt.

## Operation (continued)

### Kick starter

Use the kick starter to start the engine if the battery is drained. Once started, leave the engine running until the battery recharges sufficiently to restart the scooter.

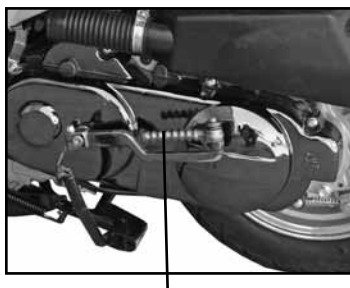

Kick starter

### Left switch assembly

- **High/low beam light switch (1):** To activate the high beam, move the switch to position (2). For low beam, use position (3).
- **Turn signal switch (4):** Slide the switch plate left for a left signal and right for a right signal. Press the center of the switch to cancel the turn signal.
- **Horn (5):** Press the bottom button to sound the horn.

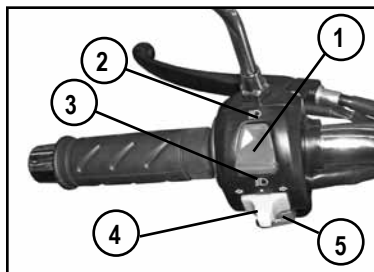

## Operation (continued)

### Instrumental panel

- **Speedometer (1):** Indicates the current driving speed in both mph and km/h.
- **High beam indication lamp (2):** Illuminates when high beam is selected.
- **Turn signal lamp (3):** Indicates that the turn signal is activated.
- **Fuel indicator (4):** Indicates the fuel level.
- **Odometer (5):** Indicates the total distance the vehicle has traveled, in km.

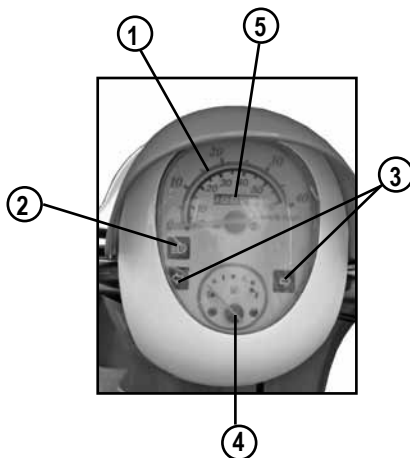

### Seat lock

- **To open:** Insert the key just below the seat on the left side of the vehicle. Press the seat down slightly while turning the key clockwise to release the latch. Lift the seat.
- **To close:** Press down the seat until locked, then remove the key. Never leave the key in the lock.



Seat lock

## Operation (continued)

### Fuel tank

The gas cap is located under the seat. To open, unlock and lift seat.



**WARNING! GASOLINE IS FLAMMABLE AND EXPLOSIVE. USE EXTREME CAUTION WHEN FUELING YOUR SCOOTER ONLY FILL THE TANK IN WELL-VENTILATED AREAS. SHUT OFF THE ENGINE AND PLACE THE SCOOTER ON ITS CENTER STAND TO ENSURE PROPER FILLING WHILE ELIMINATING THE RISK OF STATIC IGNITION CAUSED BY IMPROPER GROUNDING. NEVER SMOKE NEAR GASOLINE. NEVER OVERFILL THE GAS TANK. ALWAYS MAKE SURE THE FUEL CAP IS SECURELY FASTENED AFTER EACH FUELING.**



**WARNING! DO NOT SPLASH OR SPILL GASOLINE WHILE FUELING. IF A SPILL OCCURS, IMMEDIATELY WIPE OFF ALL SURFACES PRIOR TO STARTING THE ENGINE. AVOID SKIN CONTACT WITH GASOLINE AND DO NOT BREATHE GASOLINE FUMES. KEEP GASOLINE AWAY FROM FLAMES OR ELECTRIC SPARKS.**



Gas Cap



# Maintenance

## Checking and Changing engine oil

- **Checking engine oil**

Remove engine oil dip stick cap (1). Check oil level on dipstick. Add oil if below 3/4 full. Refer to page 13 for correct engine oil type.



- **Changing engine oil**

To drain old engine oil, place catch basin under engine and unscrew drain plug (2) located on bottom left side of engine. Drain engine oil into proper catch basin. Dispose of oil properly at oil reclaim facility.

- **Cleaning oil filter**

Drain engine oil per instructions above. Remove oil filter plug (2) located at bottom right side of engine. Remove screen filter (3) from spring assembly. Clean screen with solvent. Re-install filter and refill with 0.5 qt. oil. Refer to page 13 for correct engine oil type.

<b>CAUTION</b>
Never start the engine when there is insufficient lubricating oil. Otherwise, it will cause harm to the engine.



## Maintenance (continued)

### Changing Transmission oil

The transmission oil was filled at the factory before shipment, Drain and refill transmission oil every 5000km (3100 miles)

- **Draining transmission oil**

Drain transmission oil by removing drain screw (1) located on bottom of transmission (2) . Drain oil into a catch basin and dispose of properly at oil reclaim facility

- **Adding Transmission oil**

Add transmission oil by removing transmission oil fill cap (3) located on the side of transmission (2) . Add .12L (4oz) 80W-90 gear oil

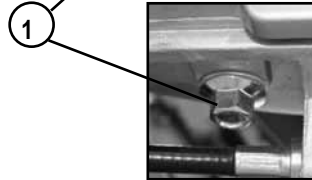
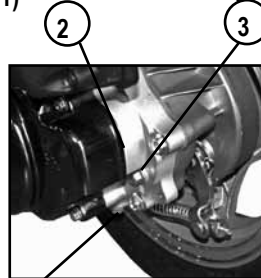
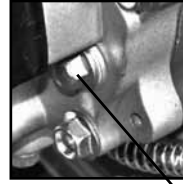

## Spark Plug

### CHECK-UP OF SPARK PLUG

1. Remove the cap of spark plug and spark plug.
2. Clean spark plug all around or replace it if it is corroded or there is too much deposit on it.
3. Regulate the gap of the spark plug to 0.6-0.7mm (.024" - .028")
3. The spark plug of the designated type should be used. The applicable type of spark plug: DR7HSA (NGK), A7RTC (TORCH)



0.6~0.7mm  
(.024" - .028")

## Maintenance (continued)

### Air filter

#### Checking Air filter

The air filter (1) is located on the left side of the scooter. Remove air filter cover by removing screws (2). If filter is dirty, follow cleaning instructions below.

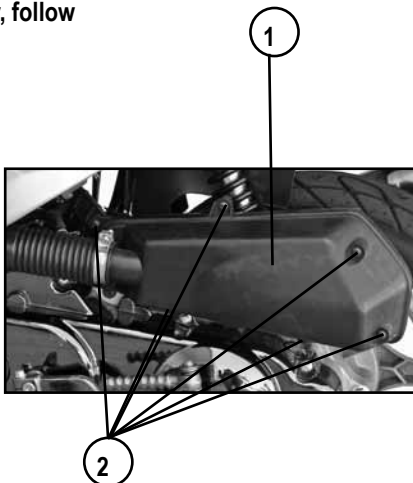
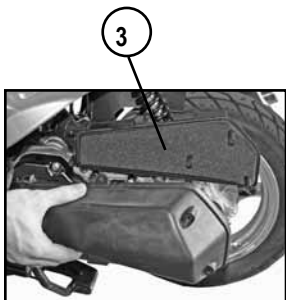

#### Cleaning Air filter

1. Remove foam element (3) from air filter housing (1).
2. Wash foam element (3) in water or a mild non flammable solvent.
3. Squeeze water out of foam element and let dry.
4. Re-install foam element (3) in air filter housing.



## Maintenance (continued)

### Brakes

#### FRONT HYDRAULIC DISK BRAKE INSPECTION

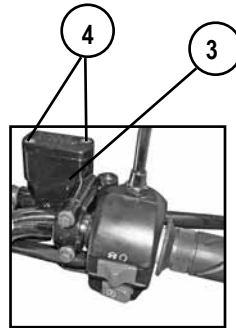

1. Inspect front disk brake caliper (1) for leakage. If brake fluid leaks, the safety of riding could be affected.
2. Inspect the brake hose (2) for cracks, and the joint for leakage.
3. Check the brake fluid level through the sight gauge on front of brake fluid reservoir (3). If level is at or below the LOWER mark, inspect brake pads for wear and hydraulic system for leaks.
4. To add brake fluid, unscrew the 2 screws (4) on top of the brake fluid container located on right handlebar. Add DOT3 or DOT4 brake fluid. Do not mix brake fluid types.

#### ADJUSTMENT OF REAR BRAKE

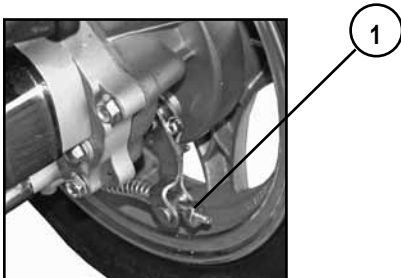

1. To make rear break adjustment, turn rear adjusting nut (1) clockwise to increase and counterclockwise to reduce tension on the brake cable.
2. Brake shoes should be replaced by a qualified service technician once worn.

## Maintenance (continued)

### Idle speed adjustment

To adjust the idle speed properly, you need a tachometer. If you do not have one, ask your authorized service center to perform this adjustment.



Engine Idle adjustment Screw

To adjust the idle speed:

1. Start the engine and warm it up.
2. Turn the engine idle screw in or out so that the engine idle speed is at 1450~1550 r/min.

#### **▲ WARNING**

Improper adjustment of the idle speed could be hazardous.

An idle speed that is too high could cause the scooter to move forward when you start the engine. This may cause an accident. Excessive engine wear may also result if idle speed is adjusted improperly or when the engine is not fully warmed up. Adjust the idle to the correct speed. Make sure the engine is fully warm before adjusting the engine idle speed.

Inspect the fuel hose for damage and fuel leakage. If any defects are found, the fuel hose must be replaced.

Fuel Hose



# Maintenance (continued)

## Tires

	Front	Rear
Size	3.00 x 10	3.00 x 10

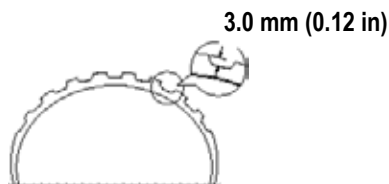

Tire Tread Condition

### ▲ WARNING

Operating this scooter with improper tires, or even improper tire air pressure could be hazardous.

If you use improper tires or improper tire air pressure, you may lose control of the scooter.

Always use the size and type of tires specified. Always maintain proper tire air pressure as described in this section.

### ▲ WARNING

Using worn tires could be hazardous.

The traction of the vehicle will be decreased. This increases your risk of having an accident.

Replace the front and rear tires when the depth on the tread is 3.0 mm (0.12 in) or less.

## Tire Air Pressure

Check the air pressure in tires before riding. Improper air pressure could affect handling, steering response, traction, tire life and rider comfort. Be sure that the tires are inflated to the pressures shown below. Tire pressure should only be measured or adjusted when the tires are cold.

	Recommended pressure
Front	36 psi
Rear	36 psi

## Maintenance (continued)

### Battery (gas scooter)

Your scooter uses a sealed, maintenance-free lead acid battery rated 12V3AH. The battery is located underneath the floorboard.

- **Charging new batteries:** Fill the battery with the acid in the pre-packed bottles and allow to rest for 30 minutes prior to sealing the battery. After sealing, Charging rate: Charge battery @ 0.7 Amps for 5 ~ 10 hours.
- **Recharging batteries:** For best results, charge the battery at a low current (see above). You can fast-charge the battery at 2A for up to 1hr. You may wish to use a trickle charger (<.5A) to keep the battery charged if you use your scooter is not used frequently or for short trips. You can attach a trickle charger for up to a week.



**WARNING! BATTERY ACID IS EXTREMELY CORROSIVE. ALWAYS WEAR GLOVES AND EYE PROTECTION WHEN HANDLING ACID. IF YOUR SKIN OR EYE CONTACTS THE ACID, IMMEDIATELY FLUSH WITH WATER FOR AT LEAST 15 MINUTES. IF SWALLOWED, DO NOT INDUCE VOMITING; CALL YOUR LOCAL POISON CONTROL CENTER.**



## **▲ WARNING**

The following procedure is very dangerous and should be performed with utmost care and attention. Wear protective eye wear, rubber gloves, and have water available should electrolyte come in contact with skin or eyes. **KEEP ALL CHILDREN AWAY FROM THE AREA WHILE THIS PROCEDURE IS BEING PERFORMED.**

### **POISON – CAUSES SEVERE BURNS**

Contains sulfuric acid.

Avoid contact with skin, eyes, or clothing

To prevent accidents, rinse empty container with water.

### **ANTIDOTE:**

External – flush with water

Internal – Call physician immediately. Drink large quantities of water or milk.

Follow with milk of magnesia, beaten eggs or vegetable.

Eyes – Flush with water for 15 minutes and get prompt medical attention.

**KEEP OUT OF REACH OF CHILDREN.**



**Note:** The following page is for vehicles with battery's containing separate electrolyte pack.

**Preparing the battery:**

- Place battery on level surface. Remove sealing tape from top. (see figure 20)
- Take the electrolyte container out of the plastic bag.
- Place electrolyte container upside down with the sealed silver mouths of the electrolyte bottles in line with the six filler holes of the battery. (see figure 21)
- Push the container down strongly enough to break the silver seals.
- As electrolyte starts flowing into battery, air bubbles will come up from the mouths of the plastic electrolyte bottles.
- Leave bottles upside down in battery holes until electrolyte is completely drained.
- Never leave children unattended around battery.
- If air bubbles cease to float to the top of the electrolyte bottles, tap lightly on top.
- **DO NOT** remove container from battery while it is draining.
- Never cut or pierce electrolyte container.
- After all the electrolyte has drained from the bottles into the battery, pull plastic electrolyte bottles gently out of the battery.
- Discard empty electrolyte bottles in a waste area that is inaccessible to children and animals.
- After filling let battery stand for at least 30 minutes before charging. This allows the electrolyte to penetrate plates for optimum performance and ensures longer battery life.
- After 30 minutes the battery is ready for its initial charge. Place cap strip loosely over the filling holes as shown in the picture. (see figure 22)



**Figure 20**



**Figure 21**



**Figure 22**

### How to Initially Charge the battery:

1. Connect the red positive (+) cable to the red positive (+) pole of the battery. (see figure 23)
2. Connect the black negative (-) cable to the black negative (-) pole of the battery. (see figure 24)

**Note:** The red positive (+) cable has a larger diameter than the black negative (-) cable.

3.

- After charging is complete, press down firmly with both hands to seat the caps. (Do not pound or hammer.) The battery is now sealed. (see figure 25)
- Locate battery compartment on scooter. The battery compartment is located under the floorboard. (see figure 26)
- Attach red positive (+) cable to positive (+) terminal on battery. Then attach black negative (-) cable to negative (-) terminal on battery.



Figure 23



Figure 24



Figure 25

### **▲ WARNING**

**NEVER REMOVE THE STRIP OF CAPS  
NOR ADD ANY WATER OR ELECTROLYTE.**



Figure 26

## Transporting

It is best to transport the scooter in the normal upright position.

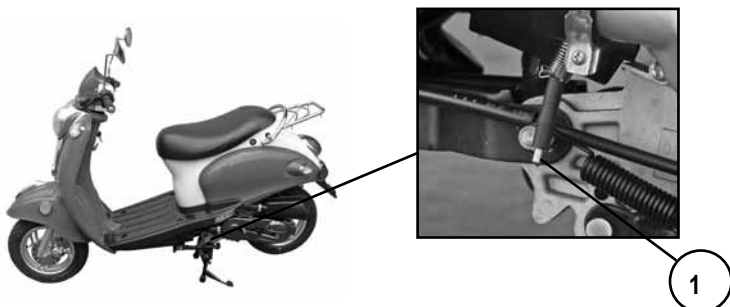

**Before transporting the scooter drain the fuel from the carburetor as follows:**

1. Drain fuel from carburetor into an empty container by loosening the carburetor drain screw (1). The carburetor drain screw is located at the bottom of the engine .
2. When the fuel has been drained, re-tighten the drain screw.

### **▲ WARNING**

Draining fuel from the carburetor could be hazardous.

Fuel could catch fire if you do not handle it properly.

When draining fuel from the carburetor, be sure to shut the engine off. Do not smoke, and never drain or refuel in an area where there are open flames or sparks. Do not spill the fuel or you may create a fire hazard. Dispose of the drained fuel properly.

### **CAUTION**

Failing to secure the Scooter properly could be hazardous.

Failing to secure the vehicle properly may result in an accident or damage to the vehicle.

When transporting the Scooter, tie down the vehicle securely with straps, rope, or some other suitable means. Use extra tie downs when you transport the vehicle in the standing position.

## Storage Procedure

If you do not use your scooter for a long period of time, it will need special service requiring appropriate materials, equipment and skill. For this reason, we recommend that you trust this maintenance work to your authorized service center. If you wish to service the machine for storage yourself, follow the general guidelines below:

### VEHICLE

Place the vehicle on level ground and wash the entire vehicle.

### FUEL

Drain the fuel from the fuel tank by a hand pump. Drain the fuel from the carburetor by releasing the carburetor drain screw.

#### **▲ WARNING**

Draining the fuel could be hazardous.

Fuel could catch fire if you do not handle it properly.

When draining the fuel from the fuel tank, be sure to shut the engine off. Do not smoke, and never drain fuel in an area where there are open flames or sparks. Keep pets and children away from the fuel, and dispose of the drained fuel properly.

### TIRES

Inflate tires to the normal pressure.

### EXTERNAL

1. Spray all vinyl and rubber parts with rubber protection.
2. Spray unpainted metal surfaces with rust preventative.
3. Coat painted and plastic surfaces with car wax.

### PROCEDURE FOR RETURNING TO SERVICE

1. Clean the entire vehicle.
2. Make sure that the vehicle is properly lubricated.
3. Perform the INSPECTION BEFORE RIDING as listed in this manual.
4. Start the vehicle as outlined in this manual.

# Maintenance Chart

It is very important to inspect and maintain your scooter regularly. Follow the guidelines in the chart. The intervals between periodic services in miles are shown. At the end of each interval be sure to perform the maintenance listed.

Item	Each use	Interval (miles)			
		Initial 150	Initial 500	Initial 1000	Every 1000
Air Filter		I Every 1000 miles (more often in dusty areas)			
* Carburetor			I		I
* Exhaust system		I	I		I
Fuel hose			I		I
Engine Oil	I	R			R
Engine Oil filter		C			C
**Transmission oil		R			
Brake Fluid level	I	I	I	I	I
Brake Hose and joints	I	I	I	I	I
Brakes	I	I	I	I	I
Wheels	I				I
Wheel bearings					I
* Brake caliper linings		I	I	I	I
Front and rear suspension					I
Steering system	I	I	I	I	I
* Steering shaft lubrication (use Li grease)					I
Fittings and Fasteners	I	T	T	T	T
* Valve Gap			I		I

\* Should be completed by an authorized service center

\*\* Change Transmission oil every 3100 miles

I=Inspect and clean, adjust, lubricate or replace, if necessary.

C=Clean

R=Replace

T=Tighten

# Troubleshooting

This troubleshooting guide is provided to help you to find the cause of some common complaints.

**COMPLAINT:** Engine is hard to start or does not start at all. Something is probably wrong with the fuel system or ignition system.

## CAUTION

Failing to troubleshoot a problem correctly can damage your Scooter.

Improper repairs or adjustments may damage the vehicle. Such damage may not be covered under warranty. If you are not sure about the proper action, consult your authorized service center or BAJA INC. about the problem.

## Fuel Supply Check

1. Make sure there is adequate fuel in the fuel tank.
2. Check that the ignition switch is in the "RUN " position.
3. Make sure there is enough fuel reaching the carburetor from the fuel tank.

## ▲ WARNING

Draining fuel from the carburetor could be hazardous.

Fuel could catch fire if you do not handle it properly.

When draining the carburetor, be sure to shut the engine off. Do not smoke, and never drain or refuel in an area where there are open flames or sparks. Do not spill the fuel or you may create a fire hazard. Dispose of drained fuel properly.

- a. Loosen the drain screw which is located under the carburetor. Drain the fuel from the carburetor into a container.
- b. Tighten the drain screw.
- c. Run the engine for a few seconds. Shut off engine.
- d. Loosen the drain screw and check that the carburetor is filled back up with fuel.
- e. If fuel is reaching the carburetor, the ignition system should be checked next.

## Trouble shooting (Continued)

### Ignition System Check

1. Remove the spark plug and reattach it to the spark plug lead.
2. Turn ignition key to the "RUN" position. Slide the engine stop switch to the "Run" position. Push the electric button "START ". If the ignition system is operating properly, a blue spark should jump across the spark plug gap. If there is no spark, take your machine to your service center.



#### **▲ WARNING**

Performing the spark test improperly could be hazardous.

You could get a high voltage electrical shock if you are not familiar with this procedure.

Do not perform this check if you are not familiar with the procedure.  
Do not point the spark plug near the spark plug hole during this test.  
Do not do this test if you have a heart condition or wear a pacemaker.  
Do not perform this test near any open fuel containers or near fuel which has spilled on the ground, on the engine, or any part of the Scooter.

#### **COMPLAINT: Engine stalls**

1. Make sure there is enough fuel in the fuel tank.
2. Check to see that the spark plug is not fouled. Remove the spark plug and clean it. Replace it, if necessary.
3. Make sure the fuel valve is not clogged, and the fuel tank is not clogged.
4. Check the idle speed. If necessary, adjust using a tachometer. The correct idle speed is 1400~1600 r/min.
5. Make sure air filter is clean.

## Specifications

Description	Data
Engine type	4-stroke/ air cooled
Overall length	1778mm (70 inches)
Overall width	66.4mm (26 inches)
Overall height	1099mm (43.25 inches)
Dead weight	73.94kg (163lbs.)
Payload	114kg (251lbs)
Suspension	Front- Telescopic fork Rear- Mono shock
Passengers	1
Transmission	CVT
Transmission oil	0.12L (4oz.) 80W90
Clutch	Auto, Centrifugal
Capacity of gasoline	4.9L (1.3 gal)
Oil capacity	0.47 L (0.5 qt.)
Lubrication method	Pressure, splash
Bore and stroke	39mm x 41.4mm
Horsepower (HP)	3.74hp
Displacement	49.5cc
Starter	Electric with supplement kick start
Brake	Front-Hydraulic Rear-Drum
Rear wheel	3.0-10 36 psi
Front wheel	3.0-10 36 psi
Spark plug	CR7HSA (NGK), A7RTC (TORCH) Gap 0.6mm-0.7mm (0.024in-0.028in)
Ignition means	CDI
Battery	12V-3AH/ YTX7A-BS



# Electrical Diagram

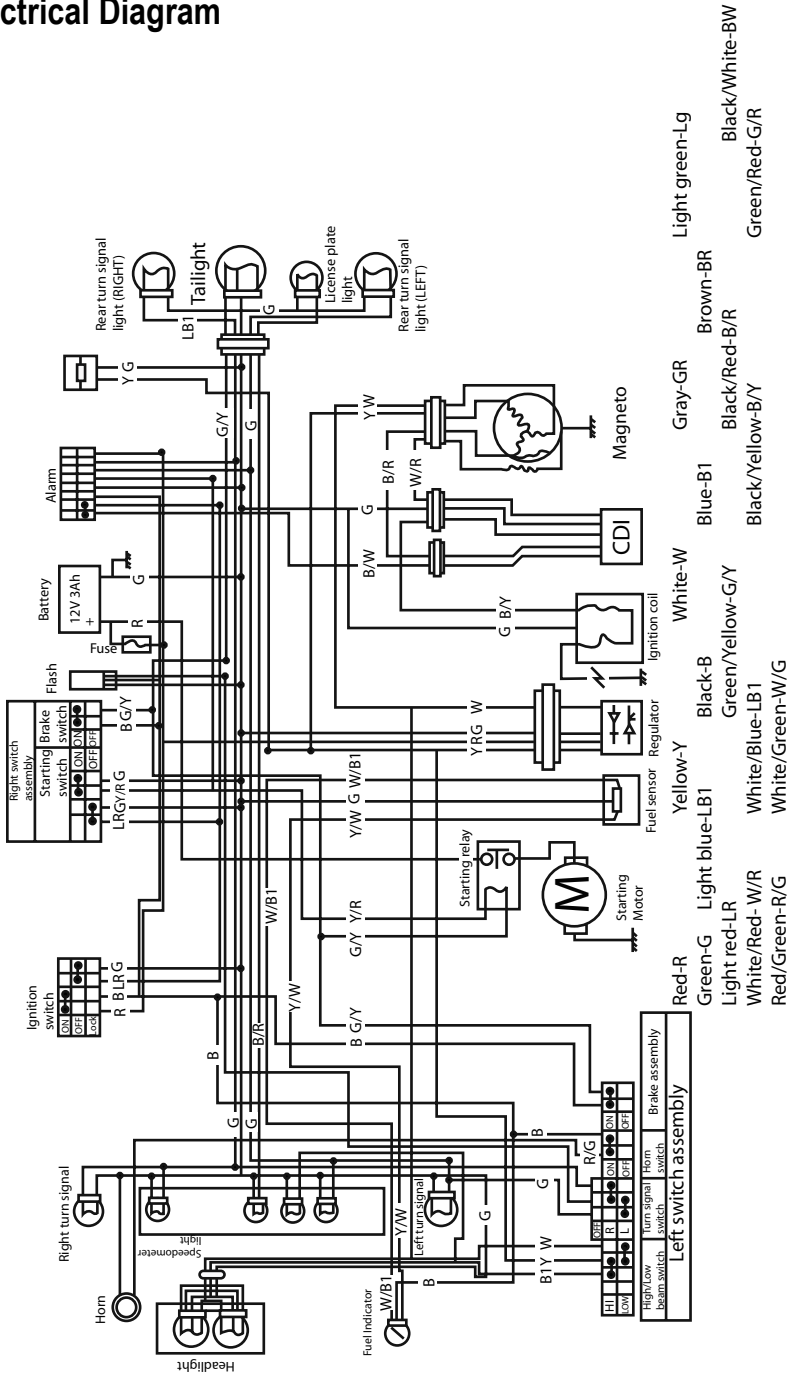

## SERIAL NUMBER LOCATION

You need to know the frame and engine serial numbers to get warranty work, theft recovery and consumer safety information. You also need these numbers to help your authorized service center or BAJA INC. order parts.

The Frame number is stamped on front of scooter just above the front floor base. A small cap will need to be removed to see the number. The engine number is located on the bottom left side of the engine housing.

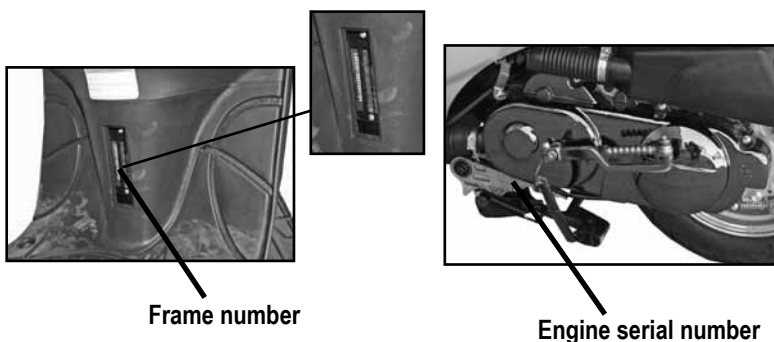

Write down the serial numbers here for your future reference

Frame No.:

Engine No.:

# Emission Control System Warranty

## BAJA INC. – EMISSION CONTROL SYSTEM WARRANTY

### YOUR WARRANTY RIGHTS AND OBLIGATIONS

The emission control system warranty period for this vehicle begins on the date the vehicle is delivered to the first purchaser other than an authorized dealer, or the date it is first used as a demonstrator, lease, or company vehicle, whichever comes first and continues for 60 months after that date, or 12,000km, whichever comes first, provided there has been no abuse, neglect or improper maintenance of your vehicle. Where a warrantable condition exists, the Distributor will repair your vehicle at no cost to you, including diagnosis, parts and labor. If an emission-related part on your vehicle is defective, the part will be repaired or replaced by the Distributor. This is your emission control defects warranty.

### OWNER'S WARRANTY RESPONSIBILITIES

As the vehicle owner, you are responsible for the performance of the required maintenance. You should maintain a record of all maintenance performed on your vehicle and retain all receipts covering maintenance on your vehicle. You may not be denied a warranty claim solely because of your failure to ensure the performance of all scheduled maintenance or lack of maintenance records or receipts. You are responsible for presenting your vehicle to an authorized dealer as soon as a problem exists. The warranty repairs should be completed in a reasonable amount of time, not to exceed 30 days.

As the vehicle owner, you should be aware that you may be denied your warranty coverage if your vehicle or a part has failed due to abuse, neglect, improper maintenance, or unapproved modifications.

### WARRANTY COVERAGE

The Distributor warrants that each new 2009 and later vehicle:

- is designed, built, and equipped so as to conform at the time of initial retail purchase with all applicable regulations of the United States Environmental Protection Agency; and
- is free from defects in material and workmanship which cause such vehicle to fail to conform with applicable regulations of the United States Environmental Protection Agency for the periods specified above.

Your emission control system warranty covers components whose failure would increase an engine's emission, including electronic controls, fuel injection system, carburetor, the ignition system, catalytic converter, or any other system utilized in this vehicle to control emission if it is originally equipped. Also included may be hoses, connectors and other emission-related assemblies. Replacing or repairing other components (including parts, labor, and other costs) not covered by this emission control system warranty or the standard warranty is the responsibility of the owner.

Coverage of repairs under this warranty applies only when repairs are completed at an authorized dealer or repair facility. The Distributor will not cover repairs performed outside of an authorized dealer or repair facility, except in an emergency situation. The use of replacement parts not equivalent to the original parts may impair the effectiveness of your vehicle's emission control system. If such a replacement part is used and an authorized dealer determines it is defective or causes a failure of a warranted part, your claim for repair to bring your vehicle into compliance with applicable standards may be denied.

If an emergency situation exists when a warranted part or a dealer is not reasonably available to the owner, repairs may be performed at any available service establishment, or by the owner, using any replacement part. The Distributor shall reimburse the owner for the expenses, including diagnostic charges, not to exceed the Distributor's suggested retail price for all warranted parts replaced and labor charges based on the Distributor's recommend time allowance for the warranty repair and the geographically appropriate hourly labor rate. The owner may reasonably be required to keep receipts and failed parts in order to receive compensation.

This Emission Control System Warranty is in addition to the standard Limited Warranty.

## EXCLUSIONS AND LIMITATIONS

This warranty does not cover the following:

- Failures or malfunctions of the emission control systems caused by abuse, alteration, accident, misuse, the use of leaded gasoline.
- Replacement of expendable maintenance items unless they are original equipment defective in material or workmanship under normal use, and the first required replacement interval for the item has not been reached. Expendable maintenance items include but not limited to spark plugs, filters, coolant, lubricants, gaskets, hoses, and belts.
- Replacements of parts and other services and adjustments for required maintenance.
- Any vehicle equipped with an odometer or hour meter where the reading is altered so that actual mileage cannot be readily determined.
- Repairs or replacements as a result of:
  - o Accident
  - o Misuse
  - o Use of replacement parts or accessories not conforming to the original specifications which adversely affect performance
- Physical damage, corrosion, or defects caused by fire, explosions or similar causes beyond the control of the Distributor.
- Failures not caused by a defect in material or workmanship.

Use of the vehicle in any type of competitive racing or related events immediately and completely voids this and all other warranties.

## LIMITED LIABILITY

The liability of the Distributor under this Emission Control System Warranty is limited solely to the remedying of defects in material workmanship by an authorized dealer at its place of business during customary business hours. This warranty does not cover inconvenience or loss of use of the vehicle or transportation of the vehicle to/from the authorized dealer. The Distributor is not liable to any person for incidental, consequential or special damages of any description, whether arising out of express or implied warranty or any other contract, negligence or other tort or otherwise.

No express emission control system warranty is given by the Distributor except as specifically set forth herein. Any emission control system warranty implied by law, including any warranty of merchantability or fitness for a particular purpose is limited to the express emission control system warranty terms stated in this warranty. The foregoing statements of warranty are exclusive and in lieu of all other remedies. All express warranties not stated in this warranty are disclaimed. Some states do not allow limitations on how long an implied warranty lasts, so the above limitations may not apply if it is inconsistent with the controlling state law.

No dealer is authorized to modify this Emission Control System Warranty. If you have any questions regarding your warranty rights and responsibilities, you should contact BAJA INC. (888) 863-2252



**BAJA INC.**

**P.O. Box 61150**

**Phoenix, AZ. 85082**

**Tel: 602-443-9180**

**Toll Free: 888-863-2252**