



## BR250/DN250 Go-Kart

Read this manual carefully. It contains important safety information.  
No one under the age of 16 should operate this Go-Kart

### OWNER'S MANUAL

Minimum Age Requirement 16



REV. B  
031109

**Always wear a helmet; It could save your Life!**

**Please obtain, review, and follow provincial / municipal government acts and regulations pertaining to owning and operating an off-road vehicle.**



**Congratulations on your purchase of the  
Baja Inc. BR250/DN250 Go-Kart.**

**It is warranted to be free of manufacturing defects in the material and workmanship for a period of 90 days from the date of purchase. During the warranty period BAJA, INC. will at its option, repair, provide replacement parts or replace your Baja Inc. BR250/DN250 Go-Kart at no charge. This warranty does not cover normal wear items or damage caused by neglect or misuse of the product.**

**Engine Warranty – 90 days  
Frame Warranty – 90 days**

**Warranty is void if:**

**Frame is bent or broken due to abuse  
Wheels are bent or broken  
Fender bent or broken due to abuse  
Any sign of impact, accident, jumping, spin-outs or roll over.**

**BAJA, INC. is not liable for any damage claim or liability claim person or otherwise resulting from the operation of this product in any way.**

**Should you experience a problem with your vehicle, please call Baja Inc. customer service line toll free at 1-888-863-2252 between the hours of 7am and 5pm Monday through Friday MST (Mountain Standard Time). MDT (Mountain Daylight Time) during the daylight saving time. You will be instructed how to proceed.**

**A COPY OF THE SALES RECEIPT IS REQUIRED.**



## **WARNING**

**This manual should be considered as a permanent part of the vehicle and should remain with the vehicle when resold or otherwise transferred to a new user or operator. The manual contains important safety information and instructions which should be read carefully before operating the vehicle.**



## **WARNING**

**The engine exhaust from this product contains chemicals known to the State of California to cause cancer, birth defects or other reproductive harm.  
CALIFORNIA PROPOSITION 65**

# TABLE OF CONTENTS

FORWARD.....	2
NOTICE TO USERS.....	3
BR250/DN250 GO-KART.....	9
FUEL AND OIL.....	10
WARNING LABELS.....	11
CONTROL PANEL AND IGNITION SWITCH.....	14
THROTTLE AND BRAKE PEDAL.....	15
PARKING BRAKE.....	15
SEAT ADJUSTMENT.....	16
RIDING YOUR GO-KART.....	17
INSPECTION BEFORE RIDING.....	18
SAFETY GEAR.....	20
BREAK-IN.....	21
DRIVE SELECT LEVER.....	22
CARBURETOR ADJUSTMENT.....	23
CHAIN AND SHOCK ADJUSTMENT.....	24
MAINTENANCE.....	25
BATTERY INSTALLATION.....	27
BATTERY REPLACEMENT.....	30
ENGINE OIL.....	31
CLEANING OIL FILTER.....	32
TRANSMISSION OIL.....	33
RADIATOR.....	34
AIR FILTER.....	35
TIRES.....	37
BRAKING.....	39
BRAKE INSPECTION.....	40
TROUBLESHOOTING.....	41
IGNITION SYSTEM CHECK.....	42
TRANSPORTING.....	43
CLEANING PROCEDURE.....	44
PREPARATION FOR CLEANING.....	44
WASHING YOUR GO-KART.....	45
INSPECTION AFTER CLEANING.....	45
STORAGE PROCEDURE.....	46
SERIAL NUMBER LOCATION.....	47
WIRE DIAGRAM.....	48
SPECIFICATIONS.....	49
EMISSION CONTROL SYSTEM WARRANTY.....	50

# FORWARD

Please read this manual and follow all instructions carefully. To emphasize the special information, the symbol▲ and the words WARNING or CAUTION have some special meanings. Pay great attention to the messages.



Indicates a potential hazard that could result in death or injury.



Indicates a potential hazard that could result in vehicle damage.

**NOTE:** Indicating special information which is to make maintenance easier or instructions clearer.

WARNING and CAUTION are arranged like this:



The first part will identify a **POTENTIAL HAZARD**.

The second part will describe **WHAT COULD HAPPEN** if you ignore the **WARNING** or **CAUTION**.



The third part will describe **HOW TO AVOID THE HAZARD**.

This user's manual contains important safety and maintenance information. Read it carefully before riding. Failing to follow the warnings contained in this manual could result in **INJURY** or **DEATH**.

It is important that this manual remain with the vehicle when you transfer it to another user or owner.

All information, illustrations, photographs and specifications contained in this manual are based on the latest product information available at the time of publication. Due to improvements or other changes, there will be some discrepancies in this manual. We reserve the right to make product changes at any time, without notice and without incurring any obligation to make the same or similar changes to the vehicle previously built or sold.

# NOTICE TO USERS

This off-road product IS NOT A TOY AND CAN BE HAZARDOUS TO OPERATE. This product handles differently from other vehicles including ATV's and motorcycles. A collision or rollover can occur quickly, even during routine maneuvers such as turning and riding on hills or over obstacles.

To help you make informed decisions about safety, you will find provided in this manual operating procedures and other safety procedures which must be followed. In addition to the safety information in this manual, you will find safety labels on the product. FOLLOW ALL WARNING BOTH IN THIS MANUAL AND ON THE PRODUCT.

Information which is particularly important is distinguished in this manual by the following notations:



FAILURE TO FOLLOW WARNING INSTRUCTIONS COULD RESULT IN SEVERE INJURY OR DEATH TO THE OPERATOR OR PASSENGER, A BYSTANDER OR A PERSON INSPECTING OR REPAIRING THE PRODUCT.



CAUTION INSTRUCTIONS ARE PROCEDURES TO PREVENT DAMAGE TO THE VEHICLE OR INJURY TO THE OPERATOR OR PASSENGER, A BYSTANDER OR A PERSON INSPECTING OR REPAIRING THE PRODUCT.

**NOTE:** A NOTE provides key information to make procedures easier or clearer.

# NOTICE TO USERS

## IMPORTANT RULES FOR SAFE OPERATION

### **WARNING**

1. This vehicle is not licensable. **IT IS NOT TO BE OPERATED ON ANY PUBLIC ROAD, STREET, HIGHWAY, PARKING LOT, SIDEWALK, OR ALLEY** To do so would be in violation of local law. This vehicle may be operated only on private property and upon areas approved by local law. Avoid operating this vehicle in any area with stationary objects that the vehicle could travel under. Do not ride in areas where other recreational vehicles are being operated. Be respectful of landowners and the environment.
2. This vehicle should **NEVER** be operated indoors. The exhaust from the engine contains carbon monoxide, which is a tasteless, odorless, and poisonous gas.
3. Unless otherwise specified in this manual, all screws, nuts, and bolts must be kept tight to ensure that the vehicle is in safe operating condition. The engine must be kept free of all dirt and other accumulations, paying particular attention to throttle linkage area.
4. Prevailing-Torque-type locknuts lose their locking capability with repeated use and require replacement. Ensure locknuts are functioning properly.
5. The tire pressure should be checked prior to each use. The recommended inflation pressure is the maximum tire pressure as printed on the tire's sidewall. **IMPROPER TIRE PRESSURE MAY CAUSE INSTABILITY AND MAY PREVENT PROPER BRAKING OR STEERING.**
6. Modifications of this vehicle or removal of any original equipment or safety decal may render the vehicle unsafe or illegal. **NEVER REMOVE ANY PROTECTIVE GUARDS OR BELT GUARDS.** These covers are for operator passenger's protection. If any guards are removed for maintenance or servicing of the vehicle, ensure that they are secured in place prior to operating the vehicle.

# NOTICE TO USERS

7. THE VEHICLE SHOULD NEVER BE STARTED WITHOUT FIRST CHECKING TO SEE THAT THE THROTTLE IS IN IDLE POSITION. Do not start engine without verifying proper function of the throttle. Never attempt to start this vehicle without having the operator seated in the proper position. When starting with the operator in the seat, the operator should have their left foot on the brake.
8. This vehicle is not designed or intended for racing, any form of competition.
9. The operator's ability to operate this off-road vehicle safely is largely dependent upon the operator's ability to exercise proper judgment. An operator also must not be too small or too large for controlled operation. The operator must be of sufficient age, understanding, mental capacity, and physical capability to safely operate this vehicle. This vehicle should only be operated after mature, supervised instruction and sufficient practice. Safe operation includes responsibility for the safety of a passenger (if any).
10. A DOUBLE SEAT VEHICLE IS DESIGNED FOR ONE OPERATOR AND ONE PASSENGER. No one should ever attempt to ride on this vehicle without being seated, with the seat belt properly secured. For double seat vehicles ridden without passenger, the passenger seat belt must be secure to prevent it from getting caught up in operating components. Any passenger must be of sufficient age, understanding, mental capacity, and physical capability to act to protect himself/herself. ALWAYS FOLLOW THE RECOMMENDED AGE RESTRICTION OF 16 YEARS FOR OPERATORS AND PASSENGERS.
11. The engine should be stopped when the vehicle is not in use.
12. The operator and passenger (if any) of this vehicle should always wear a helmet approved by agencies such as Department of Transportation (DOT), Safety Helmet Council of America (SHCA), or Snell Memorial Foundation (SNELL). Most off-road vehicle accident fatalities are due to head injuries. The operator should also wear face shields or goggles, boots or closed-toe shoes, gloves, and other appropriate protective clothing.



# NOTICE TO USERS

- 13. LOOSE CLOTHING, LONG HAIR, OR ARTICLES WORN BY ANY OPERATOR OR PASSENGER MUST BE FULLY CONTAINED OR COVERED TO PREVENT THEM FROM POSSIBLY BEING CAUGHT IN ROTATING PARTS OF THE VEHICLE OR THE SURROUNDING ENVIRONMENT WHILE RIDING. FAILURE TO OBEY COULD ENDANGER THE PERSONAL SAFETY OF THE OPERATOR OR PASSENGER.**
- 14. DO NOT PLACE HANDS, FEET, OR ANY OTHER PART OF THE BODY OR ANY CLOTHING NEAR THE ENGINE, MUFFLER, WHEELS, CHAIN AND OTHER ROTATING PARTS OF THE VEHICLE WHILE RIDING OR RUNNING THE ENGINE. Caution must be used in performing required maintenance on or near an operating engine. Special caution should be taken after the engine has been running, since the engine and other drive components may be extremely hot.**
- 15. Wet, slippery, rough, or steep terrain is potentially dangerous and may result in injury if proper caution is not observed. Slow speeds are required to safely operate this vehicle under these conditions. The operator must use mature judgment, skill, and experience to choose a speed suitable for terrain and riding conditions.**
- 16. The governor settings for this vehicle's engine must not be tampered with, altered, or changed. The governor is set by the engine manufacturer and limits the maximum speed of the engine (and vehicle) and protects the engine from damage. Excessive speeds are potentially dangerous to the operator/passenger, and the engine.**
- 17. Each time before using this vehicle, the fuel supply should be checked. The fuel tank should never be filled while the engine is running or while the engine is hot. Do not fill tank in a closed area such as a garage, while smoking, or in the vicinity of an open flame. Do not overfill the tank. There should not be any fuel in the filler neck. Replace cap tightly to prevent spillage of fuel and potential fire hazard. After filling tank, move the vehicle at least 15 feet away from the spot of filling before starting.**
- 18. If the vehicle should start making unusual noise or vibrating abnormally, the engine should be stopped and the spark plug wire disconnected. The vehicle should then be checked for damage. Excessive noise or vibration is generally a warning of loose or worn parts.**

# NOTICE TO USERS

19. When making repairs or adjustments to the vehicle which do not involve adjustments to the engine, the spark plug wire must be disconnected and kept away from the spark plug to prevent accidental starting. When working on or around, or when restarting engine, use extreme caution to avoid contact with the muffler, cylinder head, or any other potentially hot area on or around the engine.
20. Always perform a pre-ride inspection before starting the engine. See Pre-Ride Inspection section in this manual.
21. When storing the vehicle, it must be kept in a place where gasoline fumes will not reach an open flame or spark. For long period storage, such as for winter, the fuel tank should be drained in an open, cool area. The engine must be allowed to cool before storage in any enclosure. Read and keep all printed material supplied with this vehicle. Timely and specific instructions and an Operator's Manual revisions are included in supplements. If any printed material is unclear, contact the manufacturer.
22. **NEVER OPERATE THIS VEHICLE WHILE UNDER THE INFLUENCE OF ALCOHOL, DRUGS, OR MEDICATION OF ANY KIND. SUCH OPERATION COULD BE DANGEROUS TO YOURSELF AND/OR OTHERS.**
23. Always slow down when turning. High speed turning may cause loss of control, possible turnover of the vehicle, and/or possible injury to the operator or passenger.
24. While making a turn, knobby tires may increase the risk of loss of control. **ALWAYS SLOW DOWN!** A collision or rollover can occur quickly, even during routine maneuvers such as turning and riding on a hill or over obstacles.
25. **DO NOT RACE, JUMP, PERFORM "STUNT" RIDING OR "SPIN OUTS" WHEN OPERATING THIS VEHICLE. THIS VEHICLE IS NOT DESIGNED OR INTENDED FOR SUCH OPERATION.**

# NOTICE TO USERS

26. This manual, along with the other supplements provided with your vehicle, provide guidelines for the assembly, maintenance, and operation of this vehicle and is not intended as a service manual.
27. Assembly, maintenance, and/or repair of this vehicle should only be performed by persons of sufficient mechanical skill, experience, and judgment (such as outdoor equipment dealers, motorcycle dealer/shops, or small engine dealers) so that no unsafe condition or modification is made.
28. Always use extreme caution when starting the engine. Avoid touching the engine, muffler, or drive components. These areas could cause burns on contact.
29. The battery (if applicable) contains sulfuric acid and must not come in contact with skin, eyes, or clothing since this will cause severe burns possibly causing disfigurement. Also, battery may generate explosive gases and must not be exposed to sparks, flame, cigarettes, or anything flammable or an explosion may result causing severe injury. Protective gloves and face protection must be worn when servicing the battery.
30. ANY OPERATOR OR PASSENGER UNDER 18 YEARS OF AGE MUST ALWAYS BE APPROPRIATELY SUPERVISED BY AN ADULT AT ALL TIMES WHILE OPERATING THE VEHICLE.
31. Operating this vehicle requires skills acquired through practice over a period of time. Take the time to learn the basic techniques well before attempting to operate the vehicle.
32. Operate only on safe and familiar terrain. Avoid loose gravel and rocks. Be careful on wet surfaces and allow for extra braking distance.

# BR250/DN250

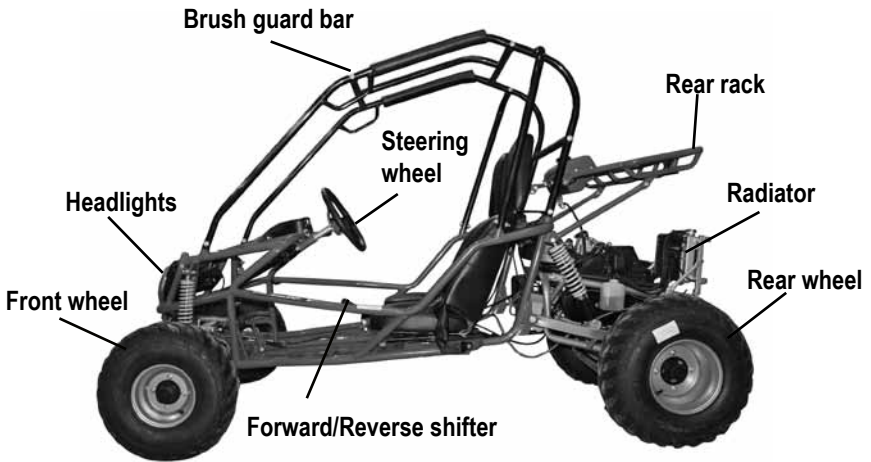

[Left]

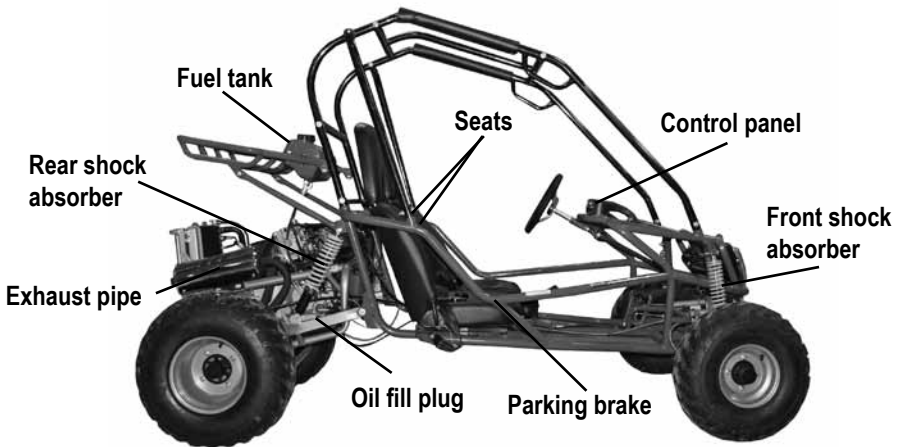

[Right]

# FUEL AND OIL

## FUEL

The proper fuel is very important for the engine. Ensure that there is no dust, dirt, or water which has mixed in the fuel. Please use regular unleaded gasoline

## ENGINE OIL

Your 250cc Go-kart has a four-stroke engine. Please use oil as described in the chart below. By using the prescribe oil, you will realize the best lubrication for the engine.

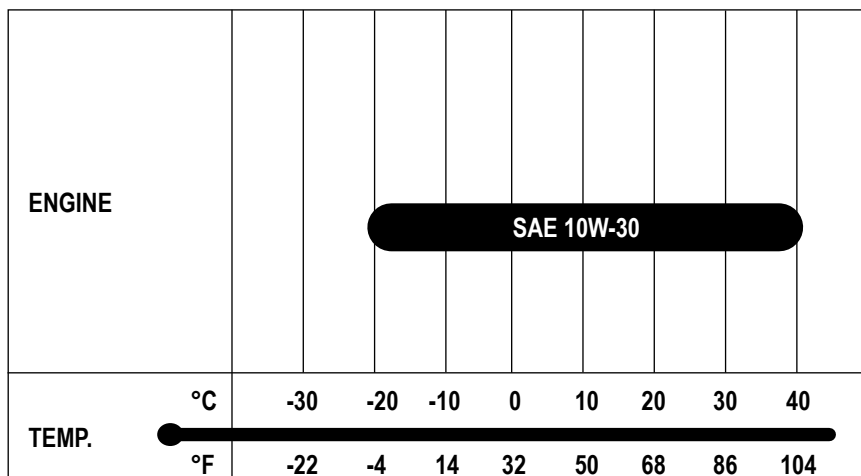

Use the chart to select a viscosity rating based on the temperature range in your area.

# WARNING LABELS

Read and follow all of the warnings labels on your Go-kart. Make sure you understand all the labels. Keep the labels on the Go-kart. Do not remove them for any reason. If a label comes off or becomes difficult to read, you should get a replacement by contacting Baja Motorsports.

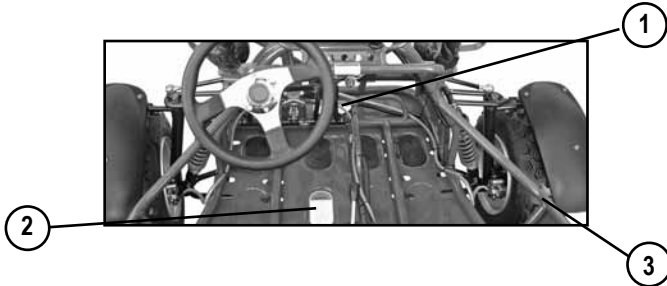

1

	<b>WARNING</b>
<p>LOSS OF CONTROL, COLLISION, OR GETTING CAUGHT IN MOVING PARTS CAN RESULT IN SERIOUS INJURIES</p> <p>Adult supervision for under 16 years olds wear a D.O.T. approved motorcycle helmet Secure long hair and loose clothing Wear protective eye wear and clothing Keep arms, legs and feet inside kart Do not use alcohol or drugs</p>	

2

	<b>WARNING</b>
<p>THIS GO-KART CAN BE HAZARDOUS TO OPERATE if driven carelessly INJURIES can result if you do not follow these instructions:</p> <p>-READ OWNER'S MANUAL AND ALL LABELS BEFORE YOU OPERATE THIS GO-KART. -NEVER OPERATE THIS GO-KART WITHOUT PROPER INSTRUCTIONS. Beginners require mature supervision. -NEVER OPERATE THIS GO-KART ON PUBLIC ROADS. it is intended off-road use only. -NEVER OPERATE THIS GO-KART AT EXCESSIVE SPEEDS. NEVER ATTEMPT WHEELIES, JUMPS, OR OTHER STUNTS.</p>	

3

	<b>WARNING</b>	<b>CAUTION</b>
<p>Seat Belt Must Be Worn At All Times</p>		<p>THIS VEHICLE MANUFACTURED FOR OFF-ROAD USE ONLY. DO NOT OPERATE ON PUBLIC STREETS, ROADS OR HIGHWAYS.</p>

# WARNING LABELS

Located on brush guard  
near control panel

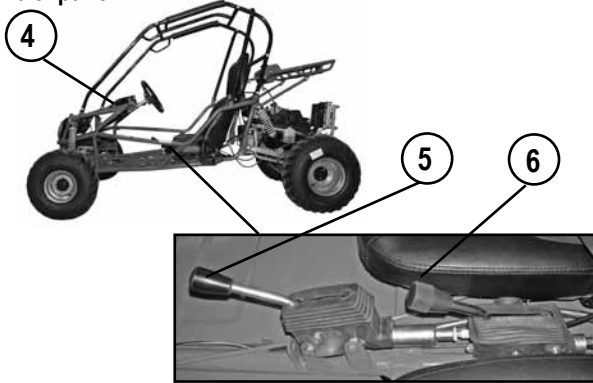

4

## ⚠ WARNING

Never attempt to switch gears while vehicle is moving!  
This will result in severe damage to reverse mechanism.  
Only switch gears when vehicle is completely still.

5



6

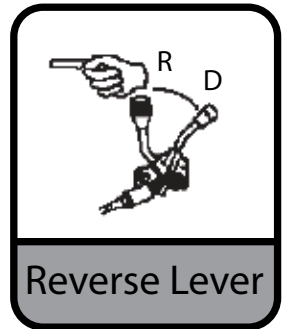

# WARNING LABELS

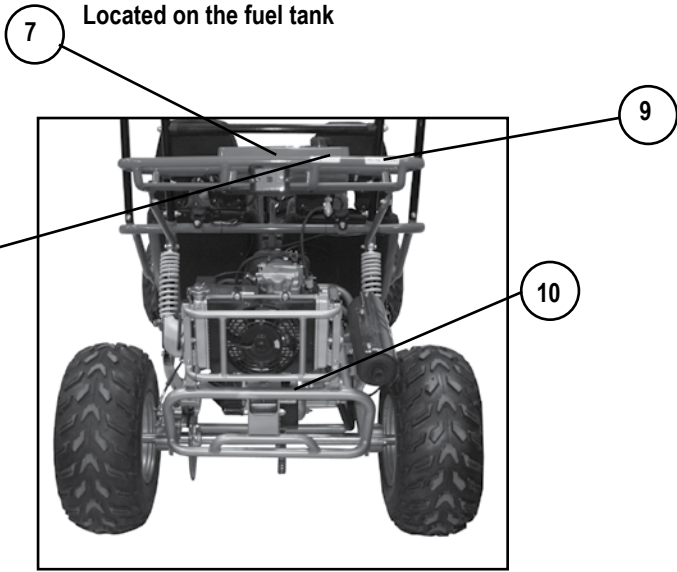

7

<b>! WARNING</b>	
NO	LONG
HAIR	
<p>ALL HAIR MUST BE TIED UP AND SECURED AT OR ABOVE SHOULDER LENGTH. ALL LOOSE CLOTHING MUST BE SECURED. ALL NECKLACES AND SCARVES MUST BE SECURED.</p>	

9	<b>! WARNING</b>
<b>LOAD LIMIT</b>	<b>NEVER sit here</b>
22lbs (10kg)	

8

	<b>! WARNING</b>
	<b>NO RIDING</b>

10

<b>! WARNING</b>	
	<ul style="list-style-type: none"> <li>-Moving parts can crush and cut.</li> <li>-Keep hands clear.</li> <li>-Do not operate with guard removed.</li> </ul>



# CONTROL PANEL AND IGNITION SWITCH

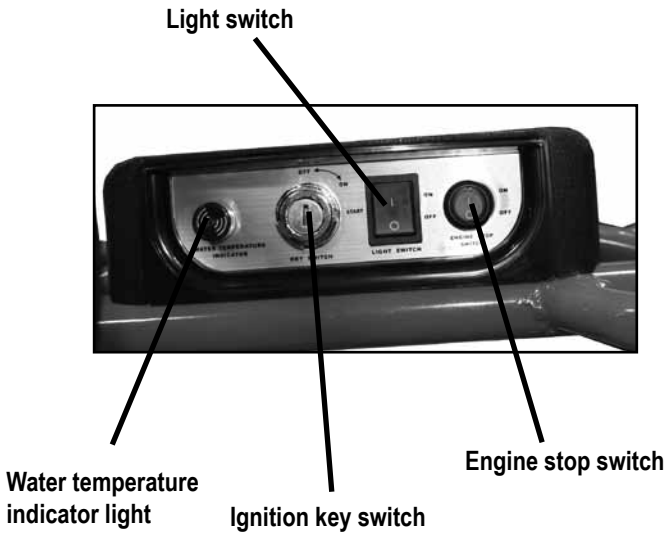

**Water temperature indicator light** - This light will illuminate when the engine is too hot.

**Ignition key switch** - To start vehicle insert key into ignition switch and turn CW (clockwise).

**Light switch**- When switch is in “ON” position lights will illuminate.

**Engine stop switch** - When engine is running move Stop switch to “OFF” position. The engine should stop when switch is depressed. If the switch fails to stop engine, consult your nearest service center.

# THROTTLE, BRAKE PEDAL AND PARKING BRAKE LEVER

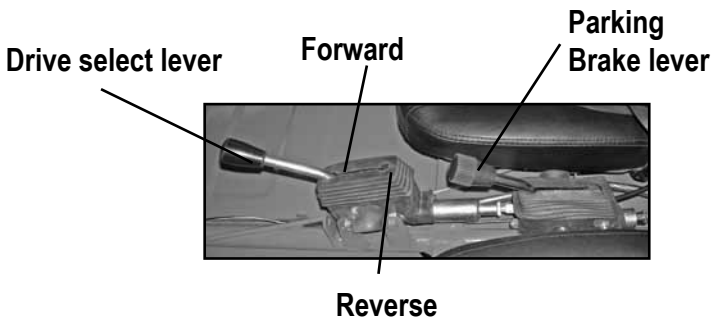
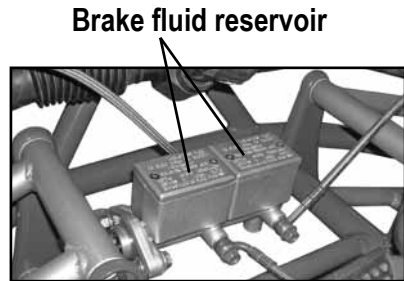
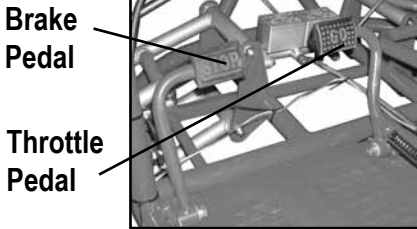

## Brake pedal

Depressing the brake pedal draws the brake calipers against the brake rotor and slows or stops the go-kart.

## Throttle pedal

Depressing the throttle pedal will engage the clutch and move the go-kart forward.

## Brake fluid reservoir

Contains brake fluid which helps to stop the go-kart. Use DOT3 or DOT4 brake fluid.

## Drive select Lever

This lever allows you to drive the vehicle in forward or reverse.

## Parking brake

While starting the engine or parking the machine, especially on a slope, apply the parking brake by pulling lever up.

# SEAT ADJUSTMENT

Pull seat adjustment handle upward to disengage the seat slide. Move the seat to desired position. Be sure the handle snaps back into place and that the seat is locked into position

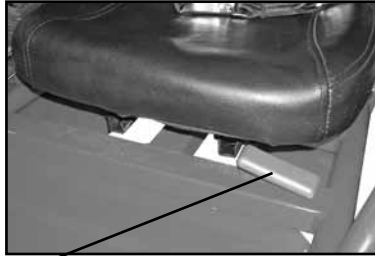

Seat adjustment handle

## **WARNING**

Before attempting to adjust the seat, ensure that the engine is not running.

Never operate go-kart when the seat is not securely adjusted. It could result in personal injuries or loss of life.

The seat must always be securely adjusted to the position which affords the best control of the foot pedals, steering wheel and engine stop switch for the operator.

# RIDING YOUR GO-KART

## WHAT YOU SHOULD KNOW BEFORE RIDING

Before riding, you should read all the following information carefully. If you are properly prepared, you will have a more enjoyable ride.

Before riding, you should find a good place to practice the skills. Find a flat, open area with enough space to practice the new skills.

Make sure that it is legal to ride in the area you selected. Review the local laws and make sure you are not trespassing. Call the police if you don't know where you can ride.

Protect your riding areas. When you are riding, remember to keep the terrain in good condition. Don't destroy plants, trees or other vegetation. Don't litter and don't bother wildlife. With your help, your riding area can remain open for use in the future.

After you have found a good place to practice, review the control system on your Go-kart before riding. Learn to find these controls without looking for them, because you will not have time to look for them when you are riding.

Canadian residents must obtain, review, and follow all provincial and municipal government acts and regulations pertaining to owning and operating an off-road vehicle.

# INSPECTION BEFORE RIDING

ITEM TO CHECK	CONTENT
Steering	Smoothness; No restriction of movement; No play or looseness
Brakes	Enough brake force; Parking brake effectiveness
Tires	Proper air pressure; Enough tread depth; No cracks, rips, or other damages
Fuel	Enough fuel for the intended trip; Fuel hose connected securely; No damage to fuel tank or cap; Fuel tank cap closed securely
Engine stop switch	Proper operation
Engine oil	Proper level – Check oil by inspecting Engine Oil Dip Stick. The engine oil should be between the Minimum and Maximum lines.
Throttle	Smooth response; quick return to idle position
General condition	Bolts and nuts are tight; no rattle from any parts of the engine when running, no visible evidence of Damage

## **WARNING**

Failing to inspect the Go-kart before operating could be hazardous. Failing to perform proper maintenance could also be hazardous.

Failing to inspect and maintain your Go-kart could increase the chances of an accident or equipment damage

Always inspect your Go-kart each time before riding, and make sure it is in a safe operating condition. Refer to the **INSPECTION AND MAINTENANCE** section in this manual.

# INSPECTION BEFORE RIDING

## WARNING

Overloading could be hazardous.

Overloading could cause changes in vehicle handling and could lead to an accident.

Never exceed the stated load capacity for this Go-kart.

## WARNING

Operating this Go-kart with improper modifications could be hazardous.

Improper installation of accessories or modifications to this vehicle may cause changes in handling. In some situations, this could lead to an accident.

Never modify this Go-kart through improper installation or use of accessories.

Check the condition of the Go-kart to make sure that the Go-kart does not have mechanical problems or you could get stranded when you ride. Before riding the Go-kart, be sure to check the above items. Be sure your Go-kart is in good condition to ensure the safety of the rider.

## WARNING

Checking maintenance items when the engine is running could be hazardous.

You could be severely injured if your hands or clothing get caught in moving Go-kart parts.

Shut the engine off when performing maintenance checks, except checking the engine stop switch and throttle.

# SAFETY GEAR

A DOT approved motorcycle helmet is the most important part of you safety gear. A DOT approved motorcycle helmet can help prevent a serious head injury. Choose a helmet that fits snugly. Motorcycle dealers can help in selecting a good quality helmet which fits properly.

## WARNING

Operating this Go-kart without wearing an approved DOT motorcycle helmet, eye protection, and protective clothing could be hazardous.

Operating without an approved DOT motorcycle helmet or eye protection increases your chances of a severe head injury or death in an accident. Operating without protective clothing also increases your chances of severe injury in an accident.

Always wear an approved DOT motorcycle helmet which fits properly. Always wear eye protection (goggles or face shield). You should also wear gloves, boots, long sleeve shirt or jacket, and long pants.

You should wear eye protection when you ride. If a rock or a branch hits your eyes, you could be severely injured. Wear goggles or a face shield.

Wear proper clothing when you ride. The proper clothes can protect you from injury. Wear a good pair of gloves, strong boots that are over the ankle, long pants, and a long sleeve shirt.

# BREAK-IN

The first month is the most important in the life of your vehicle. Proper operation during this break-in period will be helpful for assuring maximum life and performance of your new vehicle. The following guidelines explain proper break-in procedures.

## Maximum Throttle Opening Recommendation

During the first 10 hours of operation, you should always use less than ½ throttle opening.

## Vary the Engine Rotating Speed

Vary the engine rotating speed during the break-in period. This allows the parts to “load” and then “unload” (allowing the parts to cool). Although it is essential to place some stress on the engine components during break-in, you must be careful not to load the engine too much.

## Avoid Constant Low Rotating Speed

Operating the engine at constant low rotating speed (light load) can cause parts to glaze and not seal properly. Allow the engine to accelerate freely without exceeding the maximum throttle limit.

## Allow the Engine Oil to Circulate Before Riding

Allow enough idling time after warm or cold engine starting. This allows the lubricating oil to reach all critical engine components.

## Observe Your Initial and Most Critical Service

The initial service (break-in maintenance) is the most important service that your vehicle will receive. Observing a proper break-in operation, will help engine components seal properly. Maintenance required as part of the initial service includes proper adjustments, tightening of all bolts & nuts, and replacement of dirty oil. Timely performance of this service will help you get the best service life and performance of the engine.



# DRIVE SELECT LEVER

The drive select lever shifts the Go-kart in either forward or reverse

To shift Go-kart in either forward or reverse:

1. Release throttle
2. Apply brakes coming to a complete stop.
4. Shift lever in the reverse or forward position.
5. Check for people or obstacles around you.
6. Depress the throttle pedal gradually continuing to watch for people or obstacles around you.

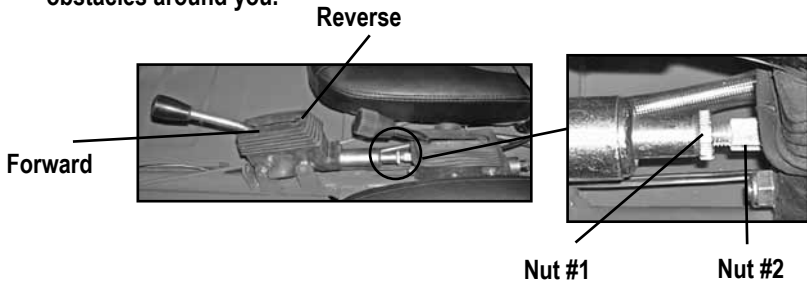

Drive select lever adjustment:

1. Press down the lever to the “D” position so that the unit can move forward.
2. Pull back the lever to “R” so that the unit can move backward.
3. Loosen Nut #1 at the end of the cable.
4. Adjust Nut #2 accordingly to adjust the mesh status inside the gear box; rotate the nut to adjust the cable, and make sure that the cable isn't too tight or too loose.
5. Make sure to re-tighten Nut #1 when adjustment is complete.

## WARNING

Not looking behind vehicle before and while going in reverse could be hazardous.

Failure to look behind while backing could cause the Go-kart to run into an obstacle or person resulting in an injury.

Before going in reverse and while backing, look behind the vehicle for any obstacles or people to avoid.

# CARBURETOR ADJUSTMENT

Never make unnecessary adjustments. The manufacturer recommended settings are correct for most applications. You will need a tachometer to make some of the adjustments. This should only be performed by a trained mechanic.

Idle speed  
adjustment screw

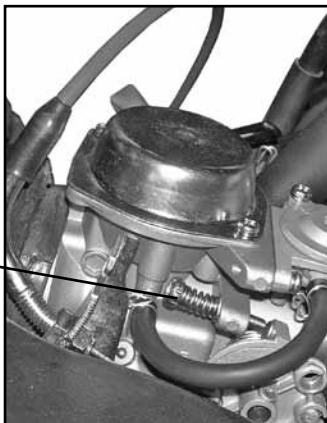

1. Warm up the engine for about 5-10 minutes.
2. Connect the tachometer, and adjust the throttle idle speed (standard value is 1700 RPM).

# CHAIN AND SHOCK ADJUSTMENT

## CHAIN ADJUSTMENT

Check the chain adjustment after the first two hours of use. Readjust if it has more than 1/2" flex.

1. Loosen nut 1.
2. Loosen nut 2.
3. Tighten or loosen adjusting cap accordingly to obtain the correct free play.
4. Once the correct free play has been achieved, tighten nut 2 then nut 1.

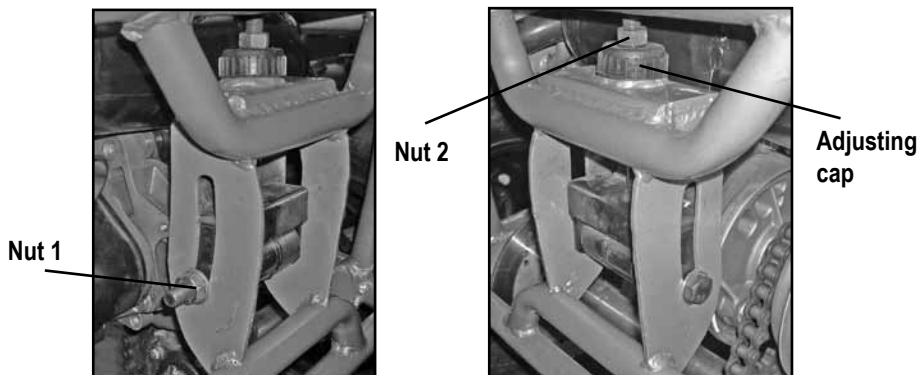

## FRONT SHOCK ADJUSTMENT

There are five adjustable positions on the front shock. The default position is in the middle set by the manufacturer.

Use a round nut wrench as you adjust the shock. The tension of shock spring will increase as you screw to the left and decrease as you screw to the right.

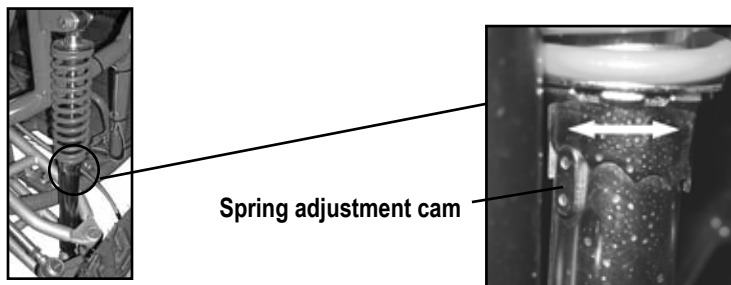

# MAINTENANCE SCHEDULE

It is very important to inspect and maintain your Go-kart regularly. Follow the guidelines in the chart. The intervals between periodic services in months are shown. At the end of each interval be sure to perform the maintenance listed.

## Periodic Check and Service

The maintenance intervals in the following table are based upon average riding conditions.

	ITEMS	1ST WEEK	MONTHLY	QUARTERLY	YEARLY
	Fuel lines		I	I	I
	Air Cleaner	C	C	I	I
*	Throttle controls	I	A	I	A
*	Spark plug		C	I	R
*	Valve clearance		I	I	I
	Engine oil	During running-in period, replace every 150 miles. After running-in period, replace every 600 miles.			
	Gearbox oil				
*	Engine oil filter screen	C	C	I	I
	Drive chain	L	A		I
*	Battery			I	
*	Disk brake		I		
	Brake system		I		
	Electrical parts		I		
	Bolts, nut and fasteners	I	I		
	Fuel tank	I	I		
*	Tire pressure/wear	I	I		
*	Steering system			A	
	Chassis	I	I		

### Note:

1. A=Adjust C=Clean I=Inspect, clean or replace if necessary L=Lubricate R=Replace
2. The items with "\*" must be inspected and repaired by professionals. If you yourself are a professional follow this owners manual and use qualified tools.
3. Driving in unusually wet or dusty areas requires more frequent services. Driving in sandy or rocky areas especially requires more frequent services.

# MAINTENANCE SCHEDULE

## WARNING

Improper maintenance or failing to perform recommended maintenance could be hazardous.

If you perform improper maintenance or do not maintain your Go-kart you may have an accident.

Keep your Go-kart in good condition. Ask your authorized service center or a qualified mechanic to do the maintenance items marked with an asterisk (\*). You may perform the unmarked maintenance items by referring to the instructions in this section if you have mechanical experience. If you are not sure how to do the maintenance ask your authorized service or call Baja Motorsports.

## WARNING

If you use your Go-kart under severe conditions, it will need maintenance more often than shown in the chart.

Operating your Go-kart under severe conditions causes more wear on your Go-kart. Severe conditions include operating under frequent full throttle, or in dusty, wet, sandy, or muddy areas. These conditions could cause the Go-kart to wear more quickly.

Perform maintenance more often than shown in the chart. If you have any questions regarding maintenance intervals, consult your authorized service center or call Baja Motorsports.

## WARNING

Using poor quality replacement parts could damage your Go-kart.

Poorly-made replacement parts could cause your Go-kart to wear more quickly and shorten its useful life.

When replacing parts on your vehicle, use only genuine replacement parts or their equivalent.

# BATTERY INSTALLATION

## INITIAL SERVICE AND INSTALLATION OF BATTERY:



## WARNING

The following procedure is very dangerous and should be performed with utmost care and attention. Wear protective eye wear, rubber gloves, and have water available should electrolyte come in contact with skin or eyes. **KEEP ALL CHILDREN AWAY FROM THE AREA WHILE THIS PROCEDURE IS BEING PERFORMED.**

### **POISON – CAUSES SEVERE BURNS**

Contains sulfuric acid.

Avoid contact with skin, eyes, or clothing

To prevent accidents, rinse empty container with water.

### **ANTIDOTE:**

External – flush with water

Internal – Call physician immediately. Drink large quantities of water or milk.

Follow with milk of magnesia, beaten eggs or vegetable.

Eyes – Flush with water for 15 minutes and get prompt medical attention.

**KEEP OUT OF REACH OF CHILDREN.**

# BATTERY INSTALLATION

**Note:** The following page is for vehicles with battery's containing separate electrolyte pack. Most battery's will come with the electrolyte already sealed into the battery.

## Preparing the battery:

- Place battery on level surface. Remove sealing tape from top. (see figure A)
- Take the electrolyte container out of the plastic bag.
- Place electrolyte container upside down with the sealed silver mouths of the electrolyte bottles in line with the six filler holes of the battery. (see figure B)
- Push the container down strongly enough to break the silver seals. (see figure B)
- As electrolyte starts flowing into battery, air bubbles will come up from the mouths of the plastic electrolyte bottles.
- Leave bottles upside down in battery holes until electrolyte is completely drained.
- Never leave children unattended around battery.
- If air bubbles cease to float to the top of the electrolyte bottles, tap lightly on top.
- **DO NOT** remove container from battery while it is draining.
- Never cut or pierce electrolyte container.
- After all the electrolyte has drained from the bottles into the battery, pull plastic electrolyte bottles gently out of the battery.
- Discard empty electrolyte bottles in a waste area that is inaccessible to children and animals.
- After filling let battery stand for at least 30 minutes before charging. This allows the electrolyte to penetrate plates for optimum performance and ensures longer battery life.
- After 30 minutes the battery is ready for its initial charge. Place cap strip loosely over the filling holes as shown in the picture. (see figure C)



Figure A



Figure B



Figure C

# BATTERY INSTALLATION

## How to Initially Charge the battery:

1. Connect the red positive (+) cable to the red positive (+) pole of the battery. (see figure D)
2. Connect the black negative (-) cable to the black negative (-) pole of the battery. (see figure E)

**Note:** The red positive (+) cable has a larger diameter than the black negative y cable.

3. **Charging rate:** Charge battery @ 0.7 Amps for 5 ~ 10 hours.
  - After charging is complete, press down firmly with both hands to seat the caps. (Do not pound or hammer.) The battery is now sealed. (see figure F)
  - Install battery into battery compartment. The battery terminals should be facing the front (see figure G)
  - Once battery is firmly seated in battery compartment attach the red positive wire to the red positive terminal on the battery.
  - Then attach the black negative wire to the black negative terminal on the battery.
  - Install the battery cover and straps (see figure G)



Figure D



Figure E



Figure F



Figure G



## WARNING

NEVER REMOVE THE STRIP OF CAPS NOR  
ADD ANY WATER OR ELECTROLYTE.



# BATTERY REPLACEMENT

- Remove old battery from under seat. The battery strap will need to be removed. Mark which cable is connected to the positive terminal (+) and which cable is connected to the negative (-) terminal.
- Clean cable connectors with wire brush or sandpaper to remove oxidation.
- After charging, install new battery. Put dielectric grease on the battery terminals to avoid corrosion. Connect cables to the proper terminals. Positive cable to positive terminal and negative cable to negative terminal.
- Positive (+) cable is red and larger in diameter. Negative (-) cable is black and smaller of the two in diameter. **CONNECT NEGATIVE CABLE LAST.**
- Torque terminal bolts to 40 in. / lbs.
- Securely fasten battery to the vehicle using metal battery strap.

## **WARNING**

**DO NOT** open sealed caps to add water to battery.

- Always wear safety glasses and charge in a ventilated area.
- If battery gets hot to the touch, discontinue charging and allow battery to cool down.
- Do not use fast charging unless it is an emergency.
- At the beginning or end of charging, turn off the charger first, in order to prevent electric spark and explosion.
- Charge in a well ventilated area.
- **DO NOT** smoke around batteries and keep away from open flame.

## **WARNING**

- To avoid possibility of explosion, always connect battery cable in the order specified: **RED** first; **BLACK** last. An exploding battery can cause serious injury or death.
- Batteries contain sulfuric acid.
- Always shield eyes with protective eye wear when working around battery acid.
- Battery acid is poisonous and can cause severe burns.
- **DO NOT** smoke around batteries and keep away from open flame.

# ENGINE OIL

## To check oil level:

1. Park vehicle on level ground.

Oil cap and dipstick

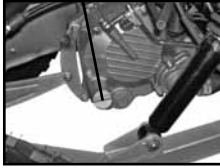

2. Remove dip stick and wipe off with a clean rag. Insert the dipstick in the filler hole.
3. Remove the dipstick and inspect the oil level.
4. Oil level should be in between the Lower index line and Upper index line marks on the dipstick.
5. Add oil if oil is below lower mark on dipstick . Do Not fill above upper mark. Refer to page 10 for correct engine oil type.

## Engine oil replacement:

The engine oil should be changed every 20 to 40 hours of operation. It should be changed more often in dirty and dusty areas.

1. Park vehicle on level ground.
2. Remove engine oil drain bolt (located on bottom right side of engine).
3. Drain oil into a catch basin and dispose of properly at an oil reclaim facility.

Engine oil drain bolt

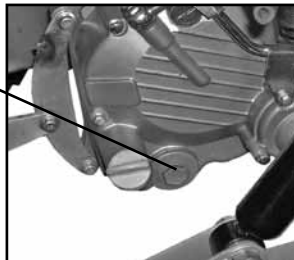

# ENGINE OIL

## Cleaning oil filter

1. Drain engine oil as instructed on page 31.
2. Remove oil filter plug (located on bottom right side of engine).
3. Remove screen filter and spring assembly.
4. Clean screen with solvent.
5. Re-install filter and refill with 1qt. oil (refer to page 10 for correct engine oil type).

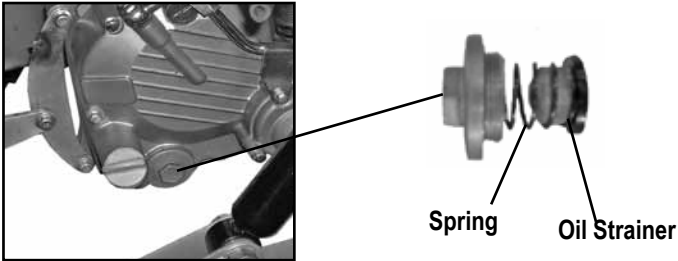

### **!** WARNING

New and used oil could be hazardous.

Children and pets may be harmed by swallowing new or used oil. Continuous contact with used oil can cause skin cancer in laboratory animals. Brief contact with the used oil may irritate the skin.

Keep new and used oil away from children and pets. To minimize your exposure to used oil, wear a long-sleeve shirt and moisture-proof gloves (such as dish washing gloves) when changing oil. If oil contacts your skin, wash thoroughly with soap and water. Launder any clothing or rags if wet with oil. Recycle or properly dispose of used oil.

### **!** WARNING

Failure to use the correct oil could harm your Go-kart.

Be sure to use the oil specified in the FUEL AND OIL RECOMMENDATION section.

# TRANSMISSION OIL

## WARNING

Running the engine without an adequate amount of engine oil could cause severe engine damage.

Running the engine without any engine oil could cause engine overheating.

Always check the amount of engine oil before starting the engine.

### Draining transmission oil

1. Drain transmission oil by removing transmission oil drain bolt (located on the bottom of transmission).
2. Drain oil into a catch basin and dispose of properly at an oil reclaim facility.

Transmission oil  
drain bolt



### Adding transmission oil

1. Add transmission oil by removing transmission oil fill plug (located on right of transmission).
2. Add 5 ounces of 80W-90 gear oil.

Transmission oil  
fill plug

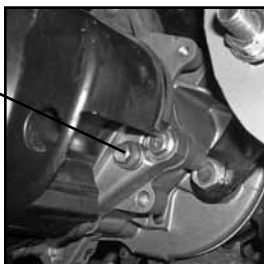

# RADIATOR

## ▲ WARNING

Removing radiator cap while engine is hot can be hazardous.

You can be seriously burned or injured by removing radiator cap while engine is hot.

**NEVER** open radiator cap while engine is hot.

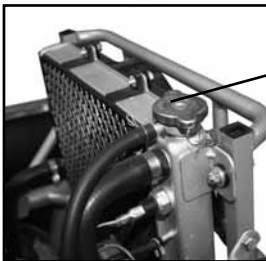

Radiator cap

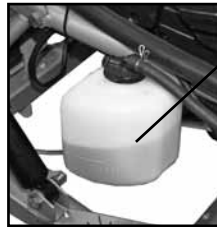

Coolant over-flow bottle

### Filling the radiator

1. Remove cap and fill radiator with radiator fluid until full.
2. Remove cap and fill coolant over-flow bottle up to the Max. line
3. After engine has been turned on and ran for awhile check coolant over-flow bottle and fill to Max. line if needed.

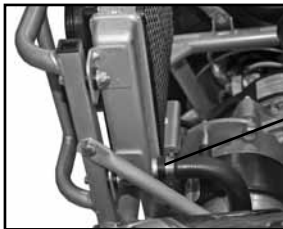

Remove hose to drain radiator fluid

### Draining the radiator

1. Remove hose and allow fluid to drain completely.
2. When radiator has completely drained, replace hose.

# AIR FILTER

The air filter element must be kept clean to provide good engine power. If you use your vehicle under normal, low-tension conditions, you should service the air filter at the intervals specified. If you ride in dusty, wet, or muddy conditions, you will need to inspect the air filter element much more frequently. Use the following procedures to remove the element and inspect it.

## AIR FILTER REMOVAL AND CLEANING

1. Locate Air Filter Box under rear rack on left side, remove cover.
2. Remove air filter.
3. Tap the Air filter element gently to remove most of the dust and dirt. Blow out remaining dust with compressed air. If the element is damaged, replace it.
4. Reinstall air filter and close cover.



**Air filter cover**

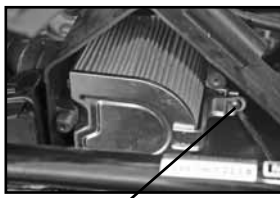

**Remove (unscrew)**



**Air Filter**

# AIR FILTER

## WARNING

Operating the engine without the air filter element in place could be hazardous.

If the air filter element did not filter dirt, severe engine damage would occur if the dirt entered the running engine.

Never run the engine without the air filter element in place.

## CAUTION

Failing to inspect the air filter element frequently if the vehicle is used in dusty, wet, or muddy conditions could damage your Go-kart.

The air filter element could become clogged under these conditions, and engine damage may result.

Always check the air filter element after riding in severe conditions. Clean or replace the elements as necessary. If water gets in the air filter case, immediately clean the element and the inside of the case.

## CAUTION

A torn air filter could damage your Go-kart.

Dirt and dust may get inside of the engine if the element is torn.

Examine carefully the element for tears before and after cleaning it. Replace the element with a new one if it is torn.

## CAUTION

Failing to position the air cleaner element properly could damage your Go-kart.

Air will bypass the air cleaner element if the element is not positioned properly. This will cause the engine parts to wear more rapidly.

Be sure to position the air cleaner element properly.

# TIRES

The Go-kart is equipped with low pressure tubeless tires of the size listed below:

	Front	Rear
Size	19x7-8	22x10-10

## CAUTION

Using worn tires could be hazardous.

The traction of the vehicle will be decreased. This increases your risk of having an accident.

Replace the front and rear tires when the depth on the tread is 3.0 mm (0.12 in) or less.

Tire Tread Condition

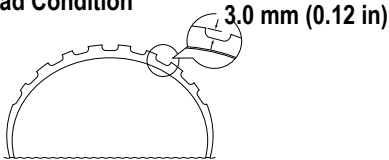

## WARNING

Operating this Go-kart with improper tires, or even improper tire air pressure could be hazardous.

If you use improper tires or improper tire air pressure, you may lose control of the Go-kart.

Always use the size and type tires specified. Always maintain proper tire air pressure as described in this section.

Tire Air Pressure

Check the air pressure in all tires before riding. Improper air pressure would effect handling, steering response, traction, tire life and rider comfort. Be sure that the tires are inflated to the pressures shown below. Tire pressure should only be measured or adjusted when the tires are cold.

	Recommended pressure
Front	14psi
Rear	14psi



# TIRES

## WARNING

Overfilling the air to the tires could be hazardous.

If you put too much air into the tire, may burst, and causing severe injury.

Check the air pressure from time to time while inflating the tire gradually, until the specified air pressure is obtained.

### Tire Replacement

Your Go-kart has low-pressure tubeless tires. Air is sealed by the contact surfaces of the inner wheel rim and the tire bead. If the inner wheel rim or tire bead is damaged, air may leak. Be extremely careful not to damage these sections when replacing tires.

It is very important to use the proper tools when repairing or replacing tires in order to protect the tire bead or wheel rims. Have this work done by your authorized service center or a qualified tire repair station.

When breaking the tire bead loose from the wheel, be extremely careful not to damage the inner wheel rim surface or the tire bead.

## WARNING

Using tires that have been installed incorrectly could be hazardous.

The Go-kart may have unusual handling if the tires are installed incorrectly.

The tires are intended to rotate in a specific direction, as indicated by the arrows on the sidewall of each tire. Install tires correctly so they rotate in the proper direction.

### Tubeless Tire Repair

If a leak or flat tire occurs due to a puncture, the tire may be repaired using a plug type patch. If the damage is from a cut, or if the puncture cannot be repaired using a plug, the tire should be replaced. When operating your Go-kart in areas where transportation or service facilities are not readily available, it is strongly recommended that you bring a plug type repair kit and a tire air pump with you.

# BRAKING

The Go-kart has Hydraulic disk brakes on all four wheels.

## WARNING

Failing to inspect and maintain your Go-kart's brake system properly could be hazardous.

Improper maintenance of the brake increases your chance of having an accident.

Be sure to inspect the brake before riding according to the **INSPECTION BEFORE RIDING** section. Always maintain your brakes according to the **MAINTENANCE SCHEDULE**.

## WARNING

Operating the Go-kart in harsh conditions could be hazardous if you do not inspect brake wear often.

Operating in mud, water, sand, or other extreme conditions can cause accelerated brake wear. This could lead to an accident.

If you operate your vehicle under these conditions, the brake must be inspected more often than recommended in the **MAINTENANCE SCHEDULE**.

# FRONT AND REAR HYDRAULIC DISK BRAKE INSPECTION

Brake fluid reservoir

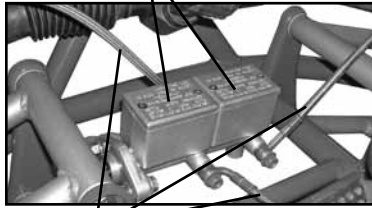

Brake hose

Front disk brake caliper



Brake disk

Brake disk

Brake hose

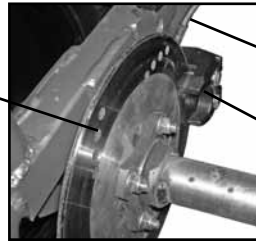

Brake hose

Rear disk brake caliper

1. Inspect the front disk brake caliper for leakage. If brake fluid leaks, the safety of riding could be affected.
2. Inspect the brake hose for cracks/damage and the joint for leakage.
3. Check the brake fluid level in the brake fluid reservoir. If level is at or below the LOWER mark, inspect brake pads for wear and hydraulic system for leaks.
4. To add brake fluid, remove the 2 screws on top of the brake fluid reservoir. Add DOT3 or DOT4 brake fluid. DO NOT mix brake fluid types.

## WARNING

Failing to maintain the brake shoes or pads could be hazardous.

Riding with worn brake shoes, pads, or shoes that are seriously worn, will increase your chance of having an accident.

If you need to replace brake shoe pads, have your authorized service center do the work. Inspecting and maintaining the brake shoe pads is recommended. Replace the shoe pads in sets.

# TROUBLESHOOTING

The following information is provided to help you identify probable questions you may have concerning the operation of you Go-kart. See your authorized service center with any additional questions you may have.

## Engine turns over but fails to start

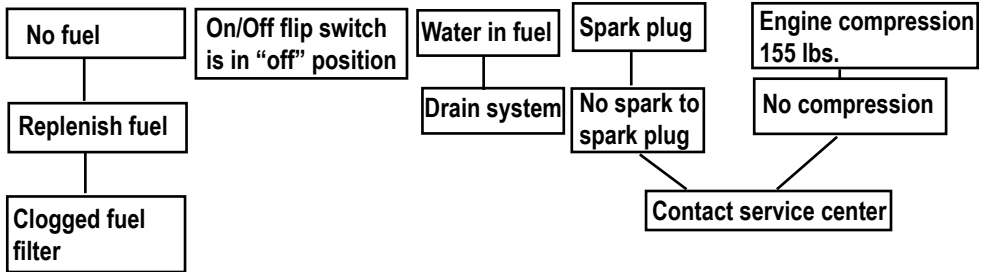

## Engine stops or loses power

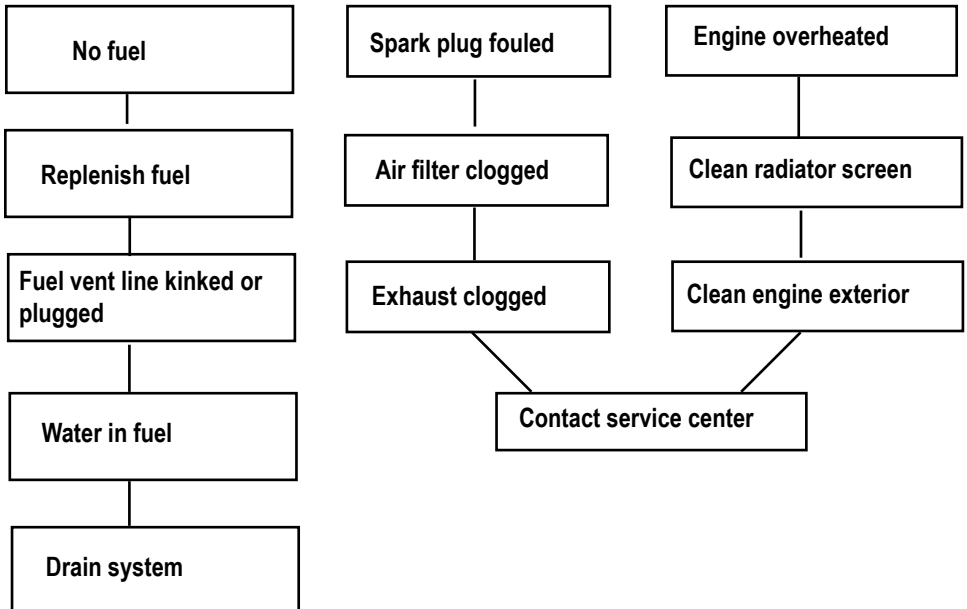

# IGNITION SYSTEM CHECK

1. Remove the spark plug and reattach it to the spark plug lead.

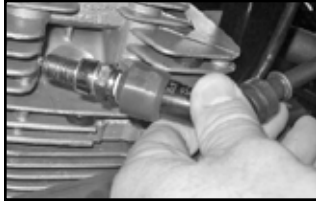

2. Turn ignition key switch CW (clockwise) to “ON” and push electric start button. Be sure the parking brake is set. If the ignition system is operating properly, a blue spark should jump across the spark plug gap. If there is no spark, take your machine to your service center.



## WARNING

Performing the spark test improperly could be hazardous.

You could get a high voltage electrical shock if you are not familiar with this procedure.

Do not perform this check if you are not familiar with the procedure. Do not point the spark plug near the spark plug hole during this test. Do not do this test if you have a heart condition or wear a pacemaker. Do not perform this test is any near any open fuel containers for near fuel which has spilled on the ground, on the engine, or any part of the Go-kart.

## COMPLAINT: Engine stalls

1. Make sure there is enough fuel in the fuel tank.
2. Check to see that the spark plug is not fouled. Remove the spark plug and clean it. Replace it, if necessary.
3. Make sure the fuel valve is not clogged, and the fuel tank is not clogged, either.
4. Check the idle speed. If necessary, adjust it using a tachometer. The correct idle speed is 1400~1600 r/min.

# TRANSPORTING

It is best to transport the Go-kart in the normal position.

Drain screw

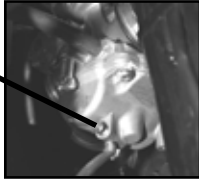

Before transporting the Go-kart drain the fuel from the carburetor as follows:

1. Drain fuel from carburetor into an empty container by loosening the carburetor drain screw located on bottom of carburetor.
2. When the fuel has been drained, retighten the drain screw.

## WARNING

Draining fuel from the carburetor could be hazardous.

Fuel could catch fire if you do not handle it properly.

When draining fuel from the carburetor, be sure to shut the engine off. Do not smoke, and never drain or refuel in an area where there are open flames or sparks. Do not spill the fuel or you may create a fire hazard. Dispose of the drained fuel properly.

## WARNING

Failing to secure the Go-kart properly could be hazardous.

Failing to secure the vehicle properly may result in an accident or damage to the vehicle.

When transporting the Go-kart, lock the parking brake lever and tie down the vehicle securely with straps, rope, or some other suitable means. Use extra tie downs when you transport the vehicle in the standing position.

# CLEANING PROCEDURE

A thorough cleaning of your Go-kart is a necessary part of maintenance. It will help keep your Go-kart looking and performing best. Proper cleaning can also extend the life of your Go-kart.

It is important to clean and inspect your Go-kart after every ride, especially if it is used in mud, brush, grass, water, salt water, or very dusty conditions

The build-up of mud, brush, grass, etc. especially on the engine and exhaust system, can reduce engine cooling ability, conceal damage, or increase wear of certain parts. It is important to remove all debris during cleaning.

## PREPARATION FOR CLEANING

Wash the Go-kart before any mud dries on the Go-kart.

Block or seal the end of the exhaust pipe (muffler) and air filter using a piece of plastic wrap, cloth rag or another method to prevent water from entering engine.

### CAUTION

High pressure washers could damage your Go-kart.

High pressure washers such as those found at coin-operated car washes have enough pressure to damage the parts of your Go-kart. It may cause rust, corrosion and increase wear.

Do not use high pressure washers to clean your Go-kart.

# WASHING YOUR GO-KART

With some care, your Go-kart can be washed in a similar manner to washing an automobile.

**Note:** Avoid spraying or allowing water to flow over the following places:

- Ignition switch
- Spark plug
- Fuel tank cap
- Carburetor
- Air filter

Use a garden hose at low pressure to remove the majority of dirt or other debris. Hand wash your Go-kart with mild soap or detergent and water. Try to thoroughly remove all dirt and debris without excessive water pressure, even at remote areas such as between engine cooling fins, linkages or mounting brackets. Cloth rags, washing mitts or cleaning brushes can be used. Be careful with brushes as they may scratch plastic or painted surfaces. Rinse the Go-kart thoroughly with clean water. Dry all areas using a chamois or soft absorbent cloth.

## INSPECTION AFTER CLEANING

Remove the rags or wrapping from the exhaust pipe. For extended life of your Go-kart, lubricate according to GENERAL LUBRICATION section.

Follow the procedures in the INSPECTION BEFORE RIDING section to check your Go-kart for any problems that may have occurred during your last ride.

### WARNING

Operating the Go-kart with wet brakes could be hazardous.

Wet brakes may not provide as much stopping power as dry brakes. This could lead to an accident.

Test your brakes after washing the Go-kart, riding at a slow speed. If necessary, apply brake several times to let the friction dry out the linings.



# STORAGE PROCEDURE

If you do not use your Go-kart for a long time, it will need special service requiring appropriate materials, equipment and skill. For this reason, we recommend that you trust this maintenance work to your authorized service center. If you wish to service the machine for storage yourself, follow the general guidelines below:

## VEHICLE

Place the vehicle on level ground and wash the entire vehicle.

## FUEL

Drain the fuel from the fuel tank by a hand pump. Drain the fuel from the carburetor by releasing the carburetor drain screw.

### WARNING

Draining the fuel could be hazardous.

Fuel could catch fire if you do not handle it properly.

When draining the fuel from the fuel tank, be sure to shut the engine off. Do not smoke, and never drain fuel in an area where there are open flames or sparks. Keep pets and children away from the fuel, and dispose of the drained fuel properly.

## TIRES

Inflate tires to the normal pressure.

## EXTERNAL

1. Spray all vinyl and rubber parts with rubber protection.
2. Spray unpainted surfaces with rust preventative.
3. Coat painted surfaces with car wax.

## PROCEDURE FOR RETURNING TO SERVICE

1. Clean the entire vehicle.
2. Make sure that the vehicle is properly lubricated.
3. Perform the INSPECTION BEFORE RIDING as listed in this manual.
4. Start the vehicle as outlined in this manual.

# SERIAL NUMBER LOCATION

You need to know the frame and engine serial numbers to get title documents for your Go-kart. You also need these numbers to help your authorized service center or Baja Motorsports order parts.

The Frame number is stamped on the frame behind the gas tank. The engine number is located on the left side of the engine housing.

Frame number

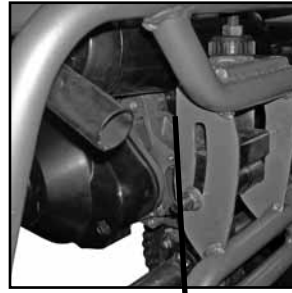
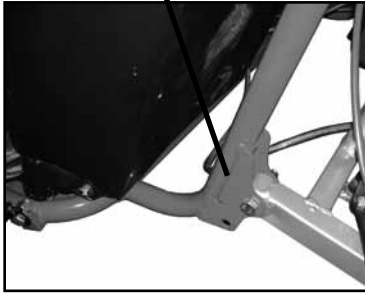

Engine serial number

Write down the serial numbers here for your future reference

Frame No.:

Engine No.:

# WIRE DIAGRAM

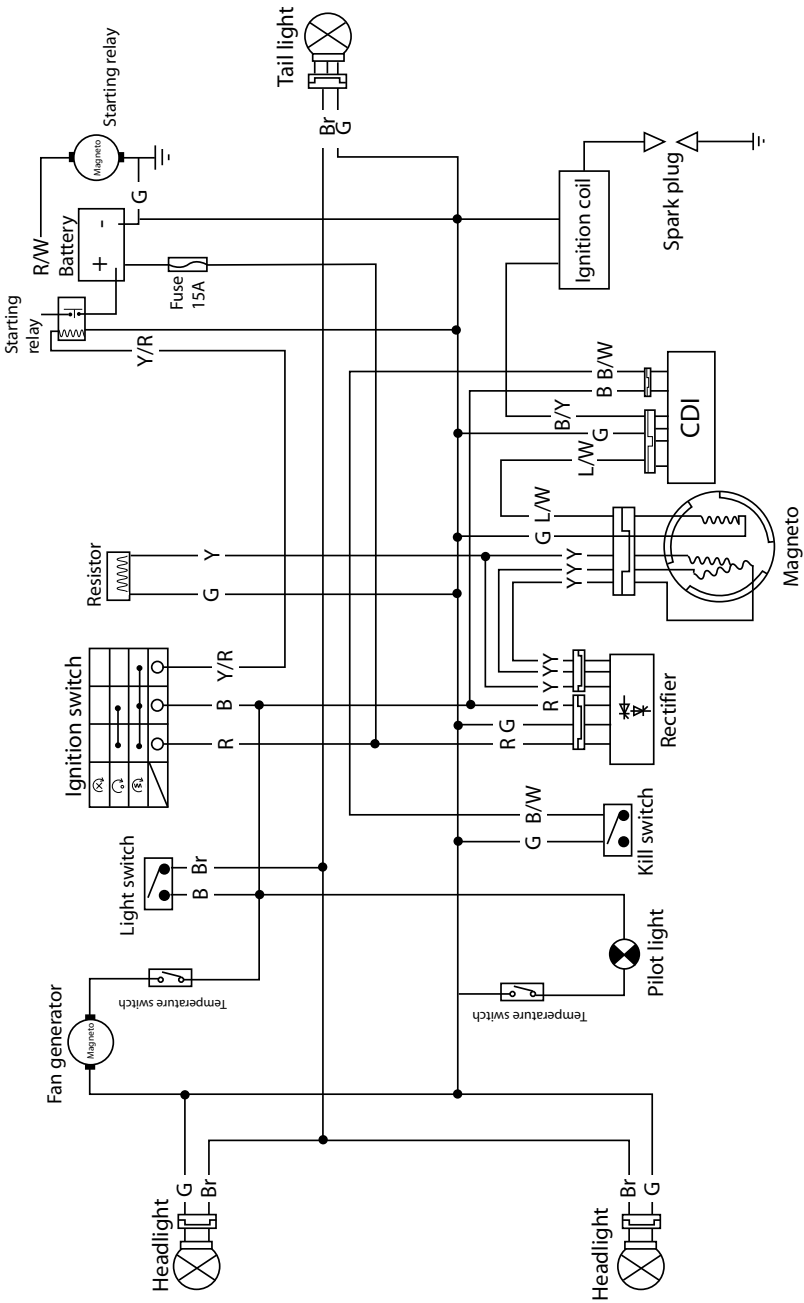

# SPECIFICATIONS

## DIMENSIONS

Overall length.....	2450mm (96.46 in.)
Overall width.....	1427mm (56.18 in.)
Overall height.....	1512mm (59.53 in.)
Wheelbase.....	1865mm (73.43 in.)
Dry weight .....	250kg (551 lbs.)
Weight limit.....	150kg (330 lbs.)

## ENGINE

Type.....	Forced water-cooled, single cylinder, 4-Stroke
Displacement.....	244.3ml
Bore X Stroke.....	72mm X 60mm
Max power.....	11kw/7000rpm
Fuel type.....	SAE 90# or above (unleaded)
Lubricate oil.....	SAE 10W/30SF
Ignition.....	C.D.I.
Starting.....	Electric
Spark plug.....	DPR7EA
Drive system.....	Chain drive
Carburetor.....	Vacuum diaphragm
Air cleaner.....	Paper element
Transmission.....	Automatic (C.V.T. system)
Gear-shifting.....	Automatic, Centrifugal
Cooling.....	Water-cooled
Cooling fluid.....	Anticorrosive. anti-freeze

## CAPACITIES

Fuel tank.....	10L (2.6 gal)
Top speed.....	70km/h (43mph)

## CHASSIS

Brake system.....	Hydraulic disc, left foot control
-------------------	--------------------------------------

## TIRE PRESSURE

Front tire size.....	19x7-8
Rear tire size.....	20x10-10

# EMISSION CONTROL SYSTEM WARRANTY

## BAJA MOTORSPORTS – EMISSION CONTROL SYSTEM WARRANTY

### YOUR WARRANTY RIGHTS AND OBLIGATIONS

The emission control system warranty period for this vehicle begins on the date the vehicle is delivered to the first purchaser other than an authorized dealer, or the date it is first used as a demonstrator, lease, or company vehicle, whichever comes first and continues for 60 months after that date, or 5,000km, whichever comes first, provided there has been no abuse, neglect or improper maintenance of your vehicle. Where a warrantable condition exists, the Distributor will repair your vehicle at no cost to you, including diagnosis, parts and labor. If an emission-related part on your vehicle is defective, the part will be repaired or replaced by the Distributor. This is your emission control defects warranty.

### OWNER'S WARRANTY RESPONSIBILITIES

As the vehicle owner, you are responsible for the performance of the required maintenance. You should maintain a record of all maintenance performed on your vehicle and retain all receipts covering maintenance on your vehicle. You may not be denied a warranty claim solely because of your failure to ensure the performance of all scheduled maintenance or lack of maintenance records or receipts. You are responsible for presenting your vehicle to an authorized dealer as soon as a problem exists. The warranty repairs should be completed in a reasonable amount of time, not to exceed 30 days.

As the vehicle owner, you should be aware that you may be denied your warranty coverage if your vehicle or a part has failed due to abuse, neglect, improper maintenance, or unapproved modifications.

### WARRANTY COVERAGE

The Distributor warrants that each new 2009 and later vehicle:

- is designed, built, and equipped so as to conform at the time of initial retail purchase with all applicable regulations of the United States Environmental Protection Agency, and the California Air Resources Board; and
- is free from defects in material and workmanship which cause such vehicle to fail to conform with applicable regulations of the United States Environmental Protection Agency or the California Air Resources Board for the periods specified above.

Your emission control system warranty covers components whose failure would increase an engine's emission, including electronic controls, fuel injection system, carburetor, the ignition system, catalytic converter, or any other system utilized in this vehicle to control emission if it is originally equipped. Also included may be hoses, connectors and other emission-related assemblies. Replacing or repairing other components (including parts, labor, and other costs) not covered by this emission control system warranty or the standard warranty is the responsibility of the owner.

Coverage of repairs under this warranty applies only when repairs are completed at an authorized dealer or repair facility. The Distributor will not cover repairs performed outside of an authorized dealer or repair facility. The use of replacement parts not equivalent to the original parts may impair the effectiveness of your vehicle's emission control system. If such a replacement part is used and an authorized dealer determines it is defective or causes a failure of a warranted part, your claim for repair to bring your vehicle into compliance with applicable standards may be denied.

This Emission Control System Warranty is in addition to the standard Limited Warranty.

# EMISSION CONTROL SYSTEM WARRANTY

## EXCLUSIONS AND LIMITATIONS

This warranty does not cover the following:

- Failures or malfunctions of the emission control systems caused by abuse, alteration, accident, misuse, the use of leaded gasoline.
- Replacement of expendable maintenance items unless they are original equipment defective in material or workmanship under normal use, and the first required replacement interval for the item has not been reached. Expendable maintenance items include but not limited to spark plugs, filters, coolant, lubricants, gaskets, hoses, and belts.
- Replacements of parts and other services and adjustments for required maintenance.
- Any vehicle equipped with an odometer or hour meter where the reading is altered so that actual mileage cannot be readily determined.
- Repairs or replacements as a result of:
  - o Accident
  - o Misuse
  - o Use of replacement parts or accessories not conforming to the original specifications which adversely affect performance
- Physical damage, corrosion, or defects caused by fire, explosions or similar causes beyond the control of the Distributor.
- Failures not caused by a defect in material or workmanship.

Use of the vehicle in any type of competitive racing or related events immediately and completely voids this and all other warranties.

## LIMITED LIABILITY

The liability of the Distributor under this Emission Control System Warranty is limited solely to the remedying of defects in material workmanship by an authorized dealer at its place of business during customary business hours. This warranty does not cover inconvenience or loss of use of the vehicle or transportation of the vehicle to/from the authorized dealer. The Distributor is not liable to any person for incidental, consequential or special damages of any description, whether arising out of express or implied warranty or any other contract, negligence or other tort or otherwise.

No express emission control system warranty is given by the Distributor except as specifically set forth herein. Any emission control system warranty implied by law, including any warranty of merchantability or fitness for a particular purpose is limited to the express emission control system warranty terms stated in this warranty. The foregoing statements of warranty are exclusive and in lieu of all other remedies. All express warranties not stated in this warranty are disclaimed. Some states do not allow limitations on how long an implied warranty lasts, so the above limitations may not apply if it is inconsistent with the controlling state law.

No dealer is authorized to modify this Emission Control System Warranty. If you have any questions regarding your warranty rights and responsibilities, you should contact BAJA MOTORSPORTS.



**Baja** Motorsports®

**Baja, INC.**

**P.O. Box 61150**

**Phoenix, AZ 85082**

**Tel: 602-443-9180**

**Toll Free: 888-863-2252**